

# MADNI



IMPEX

SURGICAL CATALOGUE



✉ [madniimpex3@gmail.com](mailto:madniimpex3@gmail.com)

## HIGH QUALITY PRODUCTS



### Plastic Body, Mini Fiber Optic (2.5 V)

Standard illumination

PSI-201 Black, PSI-202 Blue, PSI-203 Green, PSI-204 Red, With 08 disposable specula, supplied in

### Plastic Body, Mini Standard (2.5 V)

Standard illumination

PSI-205 Black, PSI-206 Blue, PSI-207 Green, PSI-208 Red, With 08 disposable specula, supplied in



### Metal Body, Fiber Optic (2.5 V)

Standard illumination

PSI-217, Complete with handle and 08 disposable specula, 01 Spare Halogen lamps, supplied in hard



### Metal Body, Fiber Optic (2.5 V)

Standard illumination

PSI-219, Complete with handle and 08 disposable specula, 01 Spare Halogen lamps, supplied in hard



### Plastic Body, Mini Fiber Optic (2.5 V)

Standard illumination

PSI-209 Black, PSI-210 Blue, PSI-211 Green, PSI-212 Red, With 08 disposable specula, supplied in

### Plastic Body, Mini Standard (2.5 V)

Standard illumination

PSI-213 Black, PSI-214 Blue, PSI-215 Green, PSI-216 Red, With 08 disposable specula, supplied in

## MEGALIGHT F.O.



Macintosh blades with *integrated* fibre-optic illumination  
Macintosh Spatel mit *integrierter* Fiber Optik

**Neu**  
Jetzt 25% mehr Licht  
durch XENON-Lampe

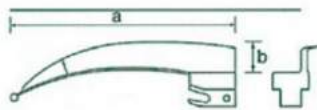

**MEGALIGHT**

Size	REF	mm
0	0001	83 x 14
1	0002	93 x 15
2	0003	119 x 20
3	0004	133 x 20
4	0005	155 x 20



laryngoscopes are modern, extremely reliable and durable quality instruments and correspond to international standard DIN 58870. An efficient 4.5 mm **Xenon** light guarantees an excellent illumination. The Xenon lamp is integrated in the handle of all **PSI** fibre-optic laryngoscopes. A good visibility increases the security for doctor and patients at the intubation process. A wide range of blades of various sizes enables the adaptation to most difficult anatomical circumstances.



Die Laryngoskope sind moderne, äußerst zuverlässige und langlebige Qualitätsinstrumente und entsprechen dem internationalen Standard DIN 58870. Ein leistungstarkes 4,5-mm-**Xenon**licht gewährleistet eine hervorragende Ausleuchtung. Bei allen **PSI** Fiber Optik-Laryngoskopen ist die **Xenon**lampe im Griff integriert. Gute Sicht erhöht die Sicherheit für Arzt und Patienten beim Intubationsvorgang. Ein umfangreiches Sortiment von Spateln verschiedener Größen ermöglicht die Anpassung an schwierigste anatomische Verhältnisse.

**Macintosh blades with *replaceable* fibre-optics**  
**Macintosh Spatel mit *auswechselbarer* Fiber Optik**

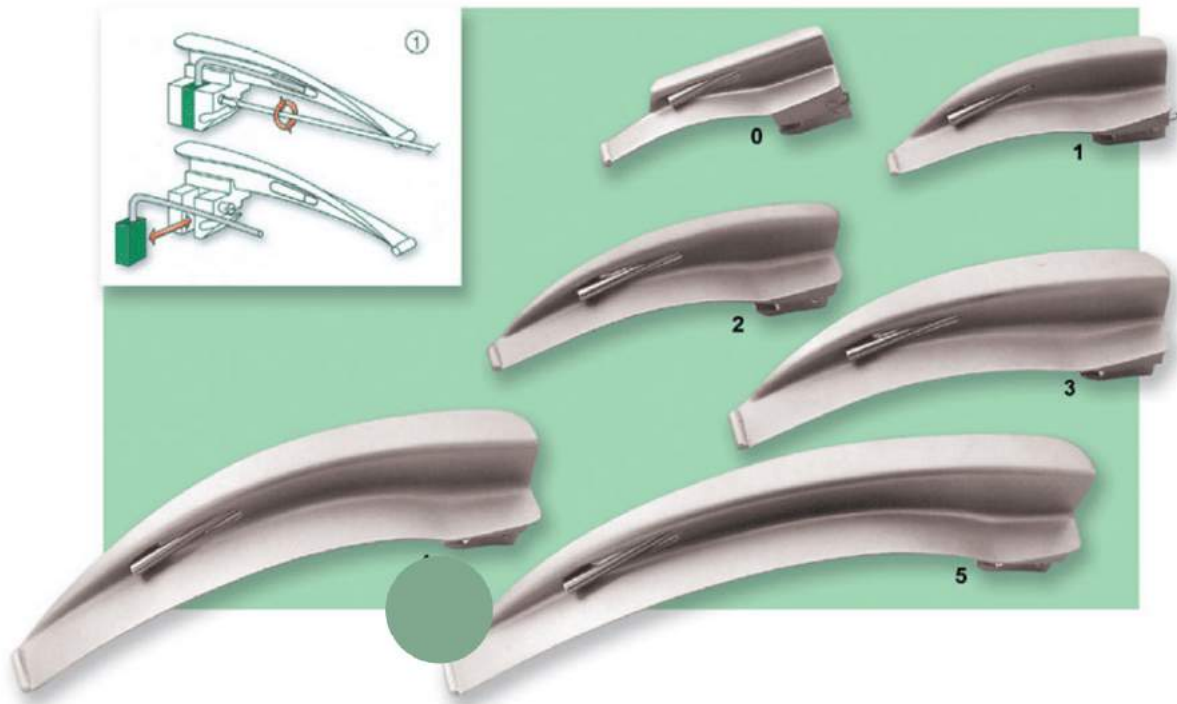

Die Alternative: Statt der Neuanschaffung eines Spatels wechseln Sie im Bedarfsfall lediglich den Lichtleiter aus.



The alternative: Instead of buying a new blade, you only change the light guide, if necessary.

① Einfaches Wechseln des Lichtleiters

① Easy replacement of the light guide

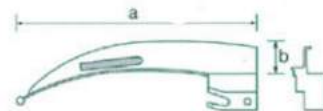

**Macintosh**

Size	REF	mm
0	0007	79 x 13
1	0008	92 x 18
2	0009	112 x 19
3	0010	133 x 22
4	0011	153 x 21
5	0012	176 x 23

## FLAPLIGHT F.O.



Flaplight F.O. Blades  
Flaplight F.O. Spatel



Flaplight F.O.

Size	REF	mm
3	0013	130 x 22
4	0014	150 x 25



**FlapLight F.O., Macintosh**  
with replacemen fibre-optics. The movable blade tip facilitates lifting of the epiglottis and enables a good visibility at the intubation process even in case of difficult anatomical conditions. An improved visibility and a lower lever action reduce the risk of injury of the larynx and the teeth. The replacement of the fibre-optic light guide cannot be made personally, but the blade has to be returned to **PSI!**

FlapLight case, only, for 2 blades and 1 handle  
blades sizes 3 + 4  
REF 28 802



**FlapLight F.O., Macintosh**  
mit auswechselbarer Fiber Optik. Die bewegliche Spatelspitze erleichtert das Anheben der Epiglot und ermöglicht auch bei schwierigen anatomischen Verhältnissen die Intubation unter Sicht. Bessere Sicht und weniger Hebelwirkung reduzieren das Verletzungsrisiko für Larynx und Zähne. Das Auswechseln der Fiber Optik kann nicht selbst vorgenommen werden. Der Spatel muss daher an **PSI** eingesandt werden!

FlapLight -Koffer, allein, für 2 Spatel und 1 Griff  
Spatel Größe 3 + 4  
REF 28 802

④

Miller blades with **replaceable** fibre-optics  
 Miller Spatel mit **auswechselbarer** Fiber Optik

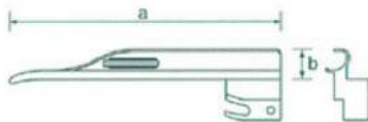

Size	REF	mm
00	0015	65 x 15
0	0016	79 x 13
1	0017	103 x 15
2	0018	156 x 15
3	0019	196 x 22
4	0020	204 x 20

**Miller**

Laryngoscope handles F.O. 2.5 V with **Xenon** illumination  
 Batteriegriffe F.O. 2,5 V mit **Xenon**beleuchtung



*25% more light !  
 25% mehr licht !*



**Battery/recharging handle, small**  
 2.5 V (AA) - Mignon  
 Ø 19 mm  
 REF 0021

**Battery/recharging handle, medium**  
 2.5 V (C) - Baby  
 Ø 28 mm  
 REF 0022

**Battery handle, large**  
 2.5 V (C) - Baby  
 Ø 32 mm  
 REF 0023

**Battery handle, short**  
 2.5 V (AA) - Mignon  
 Ø 32 mm  
 REF 0024



**Batterie-/Ladegriff, klein**  
 2.5 V (AA) - Mignon  
 Ø 19 mm  
 REF 0021

**Batterie-/Ladegriff, mittel**  
 2.5 V (C) - Baby  
 Ø 28 mm  
 REF 0022

**Batteriegriff, groß**  
 2.5 V (C) - Baby  
 Ø 32 mm  
 REF 0023

**Batteriegriff, kurz**  
 2.5 V (AA) - Mignon  
 Ø 32 mm  
 REF 0024

\* Batteries not included in scope of supply !!  
 \* Batterien nicht im Lieferumfang enthalten !!



Halogen bulb, 2.5 V

Halogenbirne, 2,5 V



Xenon bulb, 2.5 V

Xenonbirne, 2,5 V

**Accessories for fibre-optic and conventional laryngoscopes**  
**Zubehör für Faseroptik- und konventionelle Larynskope**



**Laryngoscope case only\*,**  
**for 3 blades and 1 handle**  
 Macintosh, size 0, 1, 2, 3, 4  
 Miller, size 00, 0, 1  
 Foregger, size 0, 1  
**REF 0025**

**Laryngoscope case only\*,**  
**for 5 blades and 1 handle**  
 Macintosh, size 0, 1, 2, 3, 4  
 Miller, size 00, 0, 1  
 Foregger, size 0, 1  
**REF 0026**

**Rescue bag only\*,**  
**for 4 blades and 1 handle**  
**REF 0027**



**Laryngoskope-Koffer allein\*,**  
**für 3 Spatel und 1 Griff**  
 Macintosh, Größe 0, 1, 2, 3, 4  
 Miller, Größe 00, 0, 1  
 Foregger, Größe 0, 1  
**REF 0025**

**Laryngoskope-Koffer allein\*,**  
**für 5 Spatel und 1 Griff**  
 Macintosh, Größe 0, 1, 2, 3, 4, 5  
 Miller, Größe 00, 0, 1  
 Foregger, Größe 0, 1  
**REF 0026**

**Notfalltasche allein\*,**  
**für 4 Spatel und 1 Griff**  
**REF 0027**

## FLAPLIGHT C.



**Flaplight C.** Blades, conventional  
**Flaplight C.** Spatel, konventionell



**Flaplight C.**

Size	REF	mm
3	0028	130 x 22
4	0029	150 x 25



**FlapLight C, Macintosh** for difficult anatomical intubations. Quick and efficient work will be guaranteed (see the text of our Flaplight F.O. blades).

**FlapLight case, only, for 2 blades and 1 handle**  
 blade sizes 3 + 4



**FlapLight C, Macintosh** für schwierige, anatomische Intubationen. Ein schnelles und effizientes Arbeiten wird garantiert (siehe Flaplight F.O. Spatel).

**FlapLight -Koffer, allein, für 2 Spatel und 1 Griff**  
 Spatel Größe 3 + 4

## Conventional laryngoscopes Konventionelle Laryngoskope



Macintosh blades, conventional  
Macintosh Spatel, konventionell



*PSI* provide a versatile range of conventional warmlight laryngoscopes. These instruments are of the same high and robust quality than the fibre-optic programme. The conventional *PSI* laryngoscopes have proved to be extremely reliable, precise and safe in practice for a long time. They guarantee an easy handling and a quick changing of the blade.



*PSI* bietet ein vielseitiges Sortiment an konventionellen Warmlicht-Laryngoskopen. Dies sind ebenso hochwertige, robuste Qualitätsinstrumente wie das Fiberoptikprogramm. Die konventionellen *PSI* Laryngoskope haben sich seit langem in der Praxis als äußerst verlässlich, präzise und sicher bewährt. Sie garantieren eine leichte Handhabung und ein schnelles Wechseln der Spatel.



Size	REF	mm
0	0030	80 x 13
1	0031	92 x 18
2	0032	112 x 20
3	0033	133 x 21
4	0034	153 x 21
5	0035	176 x 23

Macintosh

Miller blades, conventional  
Miller Spatel, konventionell

Foregger blades, conventional  
Foregger Spatel, konventionell

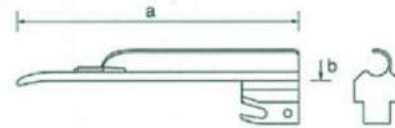
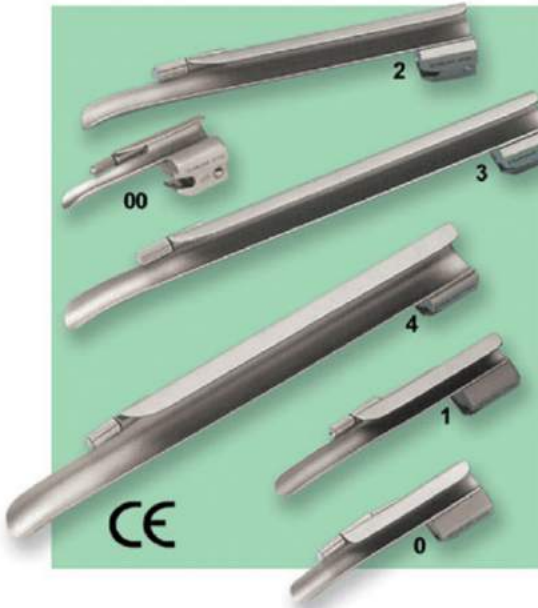

**Miller**

Size	REF	mm
00	0036	65 x 10
0	0037	79 x 10
1	0038	103 x 10
2	0039	157 x 12
3	0040	196 x 12
4	0041	205 x 16

**Foregger**

Size	REF	mm
0	0042	77 x 10
1	0043	92 x 12
2	0044	112 x 14
3	0045	132 x 16
4	0046	157 x 18

## Polio

Polio **Macintosh** blades, conventional  
 Polio **Macintosh** spatel, konventionell

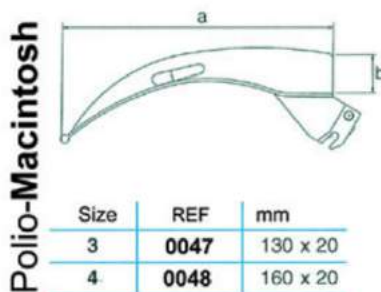
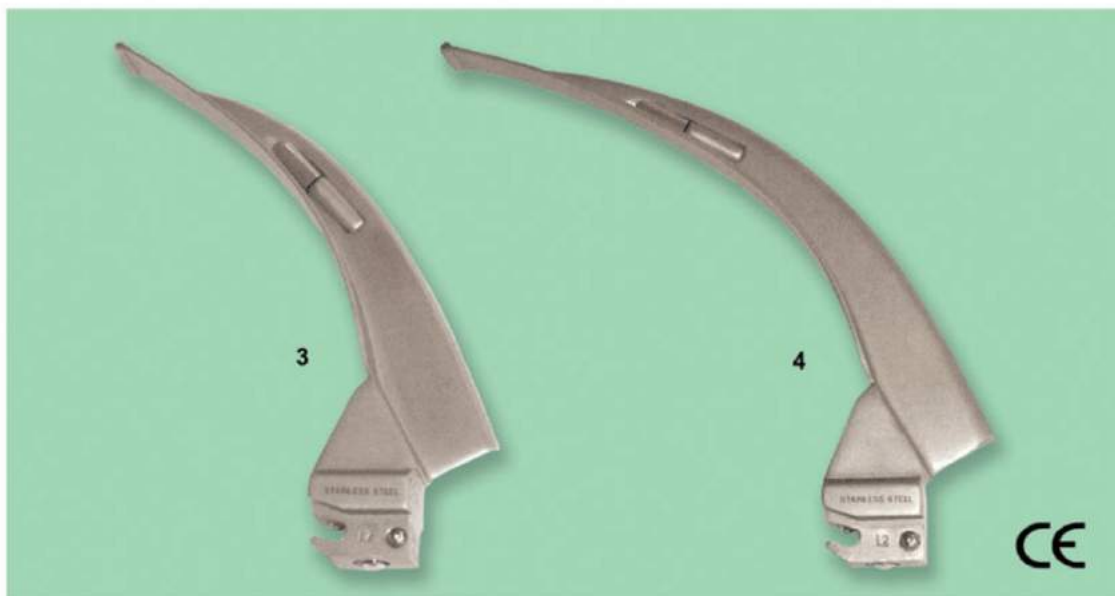

Foregger blades  
with *replaceable* fibre-optics

Foregger Spatel  
mit *auswechselbarer* Fiber Optik

Polio Macintosh blades  
with *replaceable* fibre-optics

Polio Macintosh Spatel  
mit *auswechselbarer* Fiber Optik

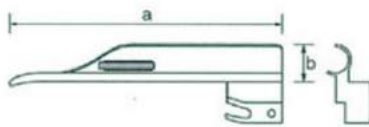

**Foregger**

Size	REF	mm
0	0049	77 x 13
1	0050	94 x 16
2	0051	113 x 17
3	0052	134 x 22
4	0053	158 x 22



**Polio-Macintosh**

Size	REF	mm	Replaceable light guide F.O.
3	0054	130 x 20	28 683
4	0055	160 x 20	28 684



**Macintosh** blades, conventional  
**Macintosh** spatel, konventionell

**Miller** blades, conventional  
**Miller** spatel, konventionell

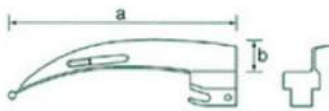
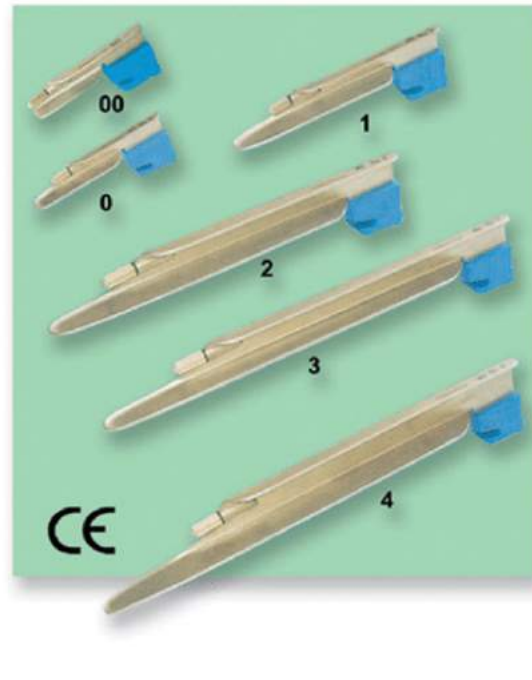
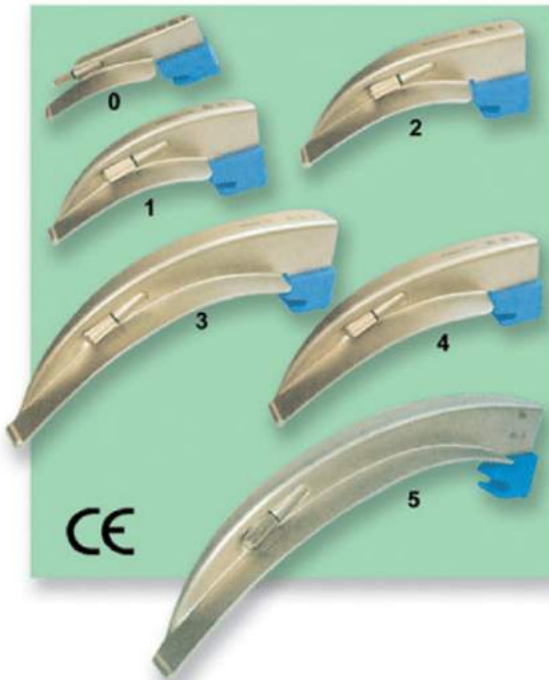

	Size	REF	mm
<b>Macintosh</b>	0	0056	80 x 13
	1	0057	92 x 18
	2	0058	112 x 20
	3	0059	133 x 21
	4	0060	153 x 21
	5	0061	176 x 23

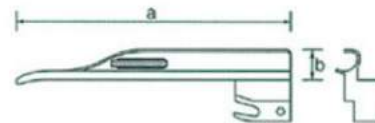

	Size	REF	mm
<b>Miller</b>	00	0062	65 x 15
	0	0063	79 x 13
	1	0064	103 x 15
	2	0065	156 x 15
	3	0066	196 x 22
	4	0067	204 x 20



Laryngoscope handles, conventional  
 Batteriegriffe, konventionell



**Battery/recharging handle, small**  
 2.5 V (AA) - Mignon  
 Ø 19 mm  
 REF 0070

**Battery/recharging handle, medium**  
 2.5 V (C) - Baby  
 Ø 28 mm  
 REF 0071

**Battery handle, large**  
 2.5 V (C) - Baby  
 Ø 32 mm  
 REF 0072

**Battery handle, short**  
 2.5 V (AA) - Mignon  
 Ø 32 mm  
 REF 0073



**Batterie-/Ladegriff, klein**  
 2.5 V (AA) - Mignon  
 Ø 19 mm  
 REF 0070

**Batterie-/Ladegriff, mittel**  
 2.5 V (C) - Baby  
 Ø 28 mm  
 REF 0071

**Batteriegriff, groß**  
 2.5 V (C) - Baby  
 Ø 32 mm  
 REF 0072

**Batteriegriff, kurz**  
 2.5 V (AA) - Mignon  
 Ø 32 mm  
 REF 0073

\* Batteries not included in scope of supply !!  
 \* Batterien nicht im Lieferumfang enthalten !!



**Krypton bulb, small,**  
 2.5V,  
 for blade sizes no. 00, 0, 1

**Kryptonbirne, klein**  
 2,5 V,  
 für Spatelgröße 00, 0, 1

**Krypton bulb, large,**  
 2.5V,  
 for blade sizes no. 2, 3, 4, 5

**Kryptonbirne, große**  
 2,5 V,  
 für Spatelgröße 2, 3, 4, 5

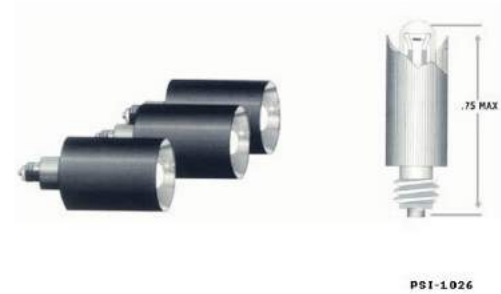
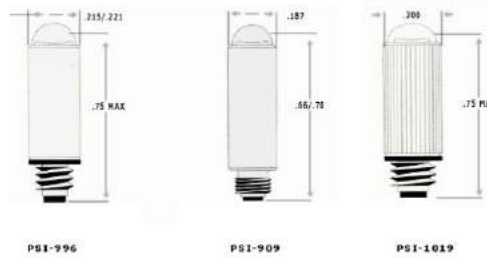
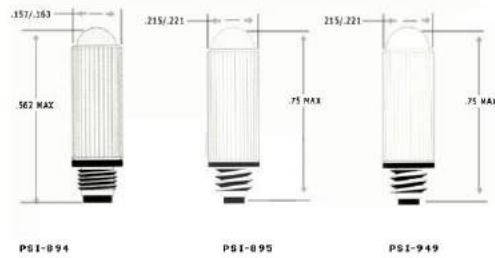

**PSI Conventional Vacuum Medical Lamps**

**Fiberoptic Medical Lamps**

PSI-894 Frosted, PSI-904 Clear, 1-8 72NS3 Thread 2.5V .28A 20 Hour Life, Nickel Plated Vacuum, T-

**PSI Conventional Vacuum Medical Lamps**

**Fiberoptic Medical Lamps**

PSI-996, 8-32 UNC 2A Thread 2.5V .35A 15 Hour, Life Nickel Plated Vacuum, TL-1 1/2 Lamp, PSI-909,

**PSI Conventional Vacuum Medical Lamps**

**Fiberoptic Medical Lamps**

PSI-1026, Mediflector 8-32 UNC 2A Thread 2.5V .30A 15 Hour Life Nickel Plated Vacuum TL-1 1/4 Lam

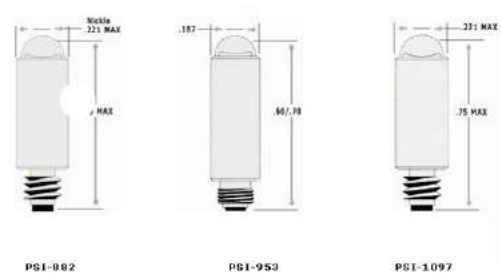
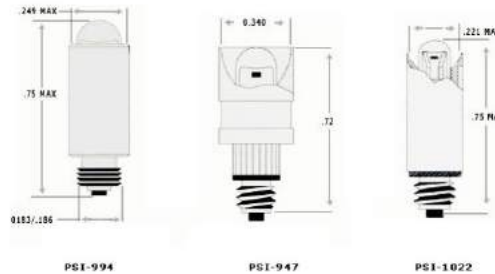
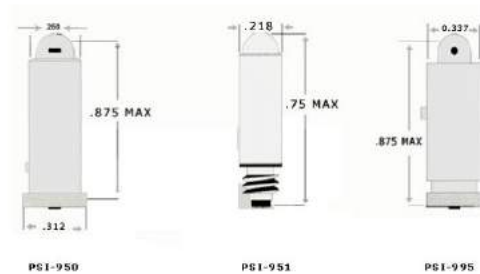

**PSI Fiberoptic Gas Filled Medical Lamps**

**Fiberoptic Medical Lamps**

PSI-950, 3.5V .7A 15 Hour Life Nickel Plated Xenon Filled T-1 1/2 Lamps, PSI-951, 10-32 thread 2.

**PSI Fiberoptic Gas Filled Medical Lamps**

**Fiberoptic Medical Lamps**

PSI-994, 48 Grooves Per inch 3.5V .72A 20 Hour Life Nickel Plated Xenon Filled TL-1 1/2 Lamp, PSI

**PSI Fiberoptic Gas Filled Medical Lamps**

**Fiberoptic Medical Lamps**

PSI-882 & Gold, PSI-883 Nicke, 8-32 UNC 2A thread 2.7V .70A 20 Hour Life(PSI-882/883) 3.5v .7



**Metal Body, Fiber Optic (2.5 V)..**

**Diagnostic Set + Ophthalmoscope Set**

PSI-220, Ophthalmoscope & Otoscope Head, Nasal Specula, Dental Mirror,  
Reusable Specula, L Pi



**Plastic Body Mini Ophthalmoscopes**

**Diagnostic Set + Ophthalmoscope Set**

PSI-221 Black, PSI-222 Blue, PSI-223 Green, PSI-224 Red, PSI  
Ophthalmoscopes with superior aspher



### Heavy Duty Tongue Depressor Holder

#### Pen Torch

PSI-224 Black, PSI-225 Blue, PSI-226 Green, PSI-227 Red, This Heavy Duty  
Tongue Depressor Holder



### Heavy Duty Pen Torch

#### Pen Torch

This is Heavy Duty Pen Torch All purpose illuminator. Supplied in Soft  
Fabric Case.



### **Soft Packing & Box**

#### **Soft Packing & Box**

PSI-234 Metal Oscope Leather Case

PSI-235 Mini Oscope Soft Case

PSI-236 Ophthalgo



### **Disposable Spatulas For Oscopes**

#### **Reusable Tips for Oscopes**

PSI-232 ..Size: 4mm

PSI-233 ..Size: 2.8mm



### PSI-STETHOSCOPE, DUAL HEAD

**PSI-01-101**

PSI-STETHOSCOPE, DUAL HEAD

Stethoscope, dual head, 1 ea.

Spectrum® dual head stethoscope:<



### PSI-SPRAGUE STETHOSCOPE

**PSI-01-102**

Features dual 22" PVC tubing for clear sound transmission and threaded soft eartips.

Red

Red



### PSI-Sprague Rappaport Type Stethoscope

**PSI-01-103**

A) Silver color head, transparent tube accessories and replacement parts



### PSI-Sprague Rappaport Type Stethoscope

**PSI-01-104**

B) Comes complete with a clear multi - pocket bag for relevant

accessories and replacement par



**Buck**

**PSI-1-101-18**

Percussion Hammer

18.5 cm



**Buck**

**PSI-1-102-18**

20cm



**Dejerine**

**PSI-1-103-20**

Percussion Hammer

20cm



**Dejerine**

**PSI-1-104-21**

Percussion Hammer

21cm



**Taylor Mod. USA**

**PSI-1-105-20**

Percussion Hammer

20cm



**Wartenberg**

**PSI-1-106-19**

Pinwheel

18 cm



**Ryder (Martin)**

**PSI-4-182-13**

Needle Holder

12.5 cm, 15 cm, 18 cm, 20 cm, 23 cm, 26 cm



**Martin**

**PSI-4-183-15**

Needle Holder mini profile elastic type

15 cm, 17 cm, 20 cm



**Wangensteen**

**PSI-4-184-27**

Needle Holder standard profile

27 cm



**Hegar-Vascular**

**PSI-4-185-14**

Needle Holder micro profile

14 cm, 18.5 cm, 20.5 cm, 23 cm

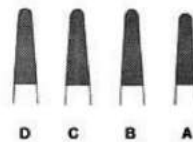

**Bozemann**

**PSI-4-186-20**

Needle Holder standard profile

20.5 cm, 24 cm, 26.5 cm, 29 cm



**Hegar**

**PSI-4-187-20**

Needle Holder standard profile

20 cm, 23.5 cm



**Pinard**  
**PSI-1-107-18**  
Stethoscope  
18 cm



**Pinard**  
**PSI-1-108-15**  
Stethoscope  
15cm



**Magill**

**PSI-2-101-15**

Catheter Introducing Forceps

14.5 cm, 20 cm, 25 cm



**Miller**

**PSI-1-101-18**

Laryngoscope Sets



**Millar-Baby**

**PSI-2-103-00**

Laryngoscope Sets



**Miller**

**PSI-2-104-00**

Laryngoscope Blade

Fig. 0, Fig. 1, Fig. 2, Fig. 3, Fig. 4



**Guedel-Negus**

**PSI-2-105-00**

Laryngoscope Sets

Fig. 2, Fig. 3, Fig. 4



**Guedel-Negus**

**PSI-2-106-00**

Laryngoscope Sets

Fig. 1, Fig. 2, Fig. 3, Fig. 4



**Guedel-Negus**

**PSI-2-107-01**

Laryngoscope Blades  
Fig. 1, Fig. 2, Fig. 3, Fig. 4



**McIntosh**

**PSI-2-108-00**

McIntosh



**McIntosh**

**PSI-2-109-0**

Laryngoscope Blades  
Fig. 0, Fig. 1, Fig. 2, Fig. 3, Fig. 4



**McIntosh**

**PSI-2-110-00**

Laryngoscope Sets  
Fig. 1, Fig. 2, Fig. 3, Fig. 4



**Foregger**

**PSI-2-111-01**

Laryngoscope Blades  
Fig. 1, Fig. 2, Fig. 3, Fig. 4



**Battery Handle**

**PSI-2-112-00**

Battery Handle



**McIntosh**

**PSI-2-114-00**

Laryngoscope Sets fiber optic

Fig. 1, Fig. 2, Fig. 3



**McIntosh**

**PSI-2-115-00**

Laryngoscope Sets fiber optic

Fig. 1, Fig. 2, Fig. 3



**McIntosh**

**PSI-2-116-00**

Laryngoscope Sets fiber optic

Fig. 1, Fig. 2, Fig. 3



**McIntosh**

**PSI-2-113-00**

Laryngoscope Sets

Fig. 1, Fig. 2, Fig. 3, Fig. 4



**Universal**

PSI-3-101-04

Trocar  
14 cm



**Nelson**

PSI-3-102-07

Trocar  
20cm



**Lichtwitz**

PSI-3-103-19

Antrum Trocar  
18.5 cm



**Adson**

PSI-3-104-21

Suction Cannula  
20cm



**Frazier**

PSI-3-105-10

Suction Cannula  
24 cm



**Frazier**

PSI-3-106-06

Suction Cannula  
19.5 cm



**Poppen**

**PSI-3-107-06**

Suction Cannula  
18 cm



**Luer**

**PSI-3-108-30**

Suction Tube working length 110 mm



**Yasargil**

**PSI-3-109-15**

Suction Tube working length 150 mm with Luer  
hub



**Yankauer**

**PSI-3-110-27**

Suction Tube complete with suction tip and  
connector  
31 cm



**Yankauer**

**PSI-3-111-00**

Suction Tube  
31 cm , 15 cm, 2.5 cm, 10 cm



**Poole**

**PSI-3-112-22**

Suction Tube  
22cm



**Pooler**  
**PSI-3-113-22**  
Suction Tube  
22.5 cm



**Nuboer**  
**PSI-3-114-21**  
Suction Tube  
21cm



**Nuboer**  
**PSI-3-115-21**  
Suction Tube  
21cm



**Quinke**  
**PSI-3-116-10**  
Lumbar Puncture Needle



**Tuohy**  
**PSI-3-117-12**  
Lumbar Puncture Needle Luer Lock connection  
with special tip



**Verres**  
**PSI-3-118-20**  
Insufflation Cannula Luer Lock connection  
15 cm



**Verres**

**PSI-3-119-20**

Insufflation Cannula Luer Lock connection

17 cm



**Kalt**

**PSI-4-105-14**

Needle Holder

13.5 cm



**Barraquer-Troutman**

**PSI-4-106-10**

Micro Needle Holder

10 cm , 10.5 cm



**Arruga**

**PSI-4-107-14**

Micro Needle Holder

13.5 cm



**Barraquer-Troutman**

**PSI-4-108-10**

Micro Needle Holder

10.5 cm , 11.5cm



**Barraquer**

**PSI-4-109-11**

Micro Needle Holder

11.5cm, 13.5 cm , 14 cm



**Barraquer**

**PSI-4-110-13**

Micro Needle Holder

13.5 cm



**Castroviejo-Fino**

**PSI-4-111-01**

Micro Needle Holder

13cm



**Castroviejo-Fino**

**PSI-4-112-01**

Micro Needle Holder

13cm



**Castroviejo-Fino**

**PSI-4-113-01**

very delicate jaw with lock

13cm



**Castroviejo**

**PSI-4-114-14**

Micro Needle Holde

Fig.65, Fig.69, Fig.88 L, 14 cm



**Castroviejo**

**PSI-4-115-14**

Micro Needle Holde

14 cm



**Castroviejo**

**PSI-4-121-14**

Micro Needle Holde

14 cm



**Castroviejo**

**PSI-4-122-14**

Micro Needle Holder

14 cm



**Castroviejo**

**PSI-4-124-13**

Micro Needle Holder with lock



**Arruga**

**PSI-4-123-16**

Needle Holder delicate

16 cm



**Castroviejo**

**PSI-4-125-12**

Micro Needle Holder with lock

12 cm



**Derf**

**PSI-4-126-12**

Needle Holder

12 cm, 13cm

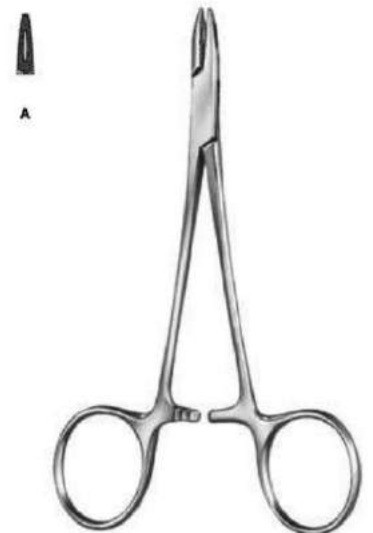

**Collier**

**PSI-4-127-12**

Needle Holder

12.5 cm



**Webster**  
**PSI-4-128-13**  
 Needle Holder  
 13cm



**Halsey**  
**PSI-4-129-13**  
 Needle Holder  
 13.5 cm

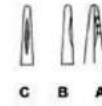

**Neivert**  
**PSI-4-130-13**  
 Neivert  
 12.5 cm



**Metzenbaum**  
**PSI-4-141-18**  
 Needle Holder one grooved and fenestrated jaw  
 18.5 cm



**M. G. Hospital**  
**PSI-4-142-17**  
 Needle Holder  
 17.5 cm



**Mayo-Hegar**  
**PSI-4-143-14**  
 Needle Holder  
 14.5 cm , 16 cm , 18.5 cm , 24 cm



**Adson**

**PSI-4-140-18**

Needle Holder one fenestrated jaw  
18 cm



**Metzenbaum**

**PSI-4-141-18**

Needle Holder one grooved and fenestrated jaw  
18.5 cm



**M. G. Hospital**

**PSI-4-142-17**

Needle Holder  
17.5 cm

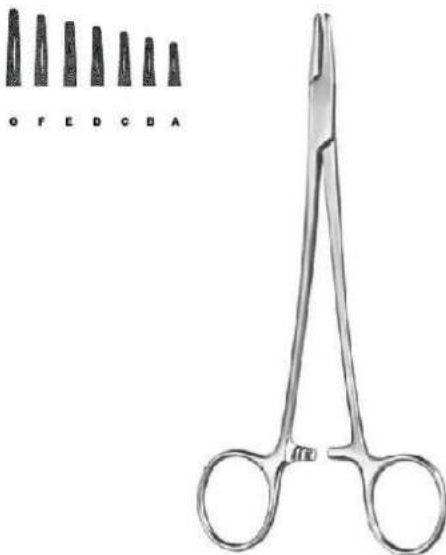

**Mayo-Hegar**

**PSI-4-143-14**

Needle Holder

14.5 cm , 16 cm , 18.5 cm , 20.5 cm , 24 cm , 26.5 cm

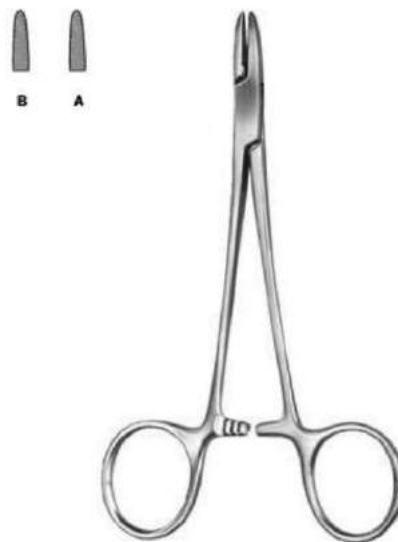

**Brown**

**PSI-4-145-13**

Needle Holder

13cm, 18 cm



**Mayo Hegar**

**PSI-4-144-16**

Needle Holder

16 cm , 18.5 cm , 20.5 cm



**Heaney**

PSI-4-146-21

Needle Holder

20.5 cm

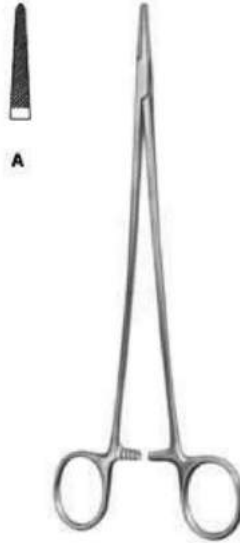

**Jamison**

PSI-4-147-23

Needle Holder

23.5 cm



**Masson**

PSI-4-148-27

Needle Holder

26.5 cm



**Finochietto**

PSI-4-149-27

Needle Holder

26.5 cm



**Wangensteen**

PSI-4-150-27

Needle Holder

26.5 cm

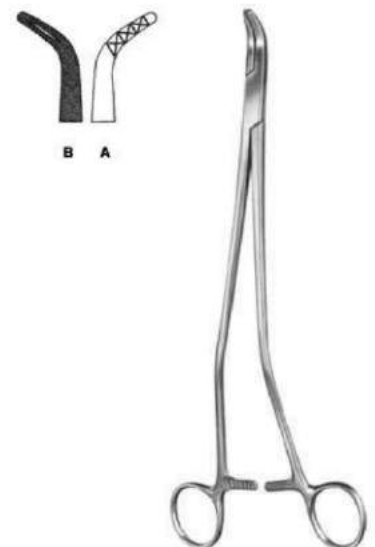

**Johnson**

PSI-4-151-27

Needle Holder

27 cm

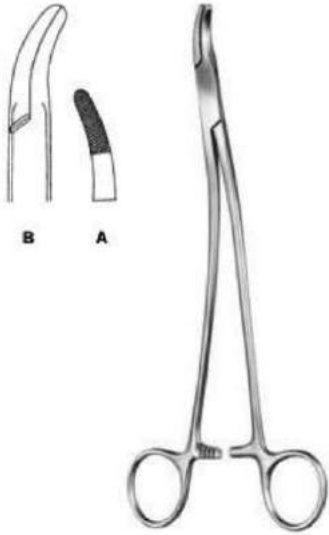

**Stratte**

**PSI-4-152-23**

Needle Holder

23 cm

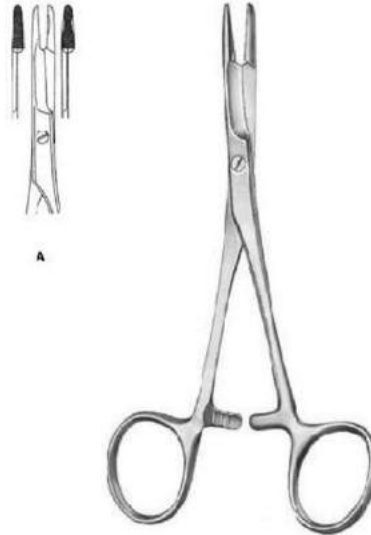

**Olsen-Hegar**

**PSI-4-153-14**

Needle Holder

14 cm

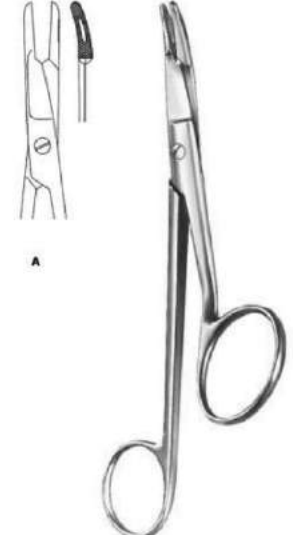

**Gillies**

**PSI-4-154-16**

Needle Holder

16 cm



**Crile**

**PSI--155-15**

Needle Holder

15 cm



**Mathieu**

**PSI-4-156-14**

Needle Holder

14 cm, 17 cm, 20cm



**Mathieu**

**PSI-4-157-14**

Needle Holder

16.5 cm



**Toennis**  
**PSI-4-158-18**  
 Needle Holder  
 18.5 cm



**Lichtenberg**  
**PSI-4-159-20**  
 Needle Holder  
 20cm



**Micro Needle Holder**  
**PSI-4-160-16**  
 Micro Needle Holder  
 16 cm



**Micro Needle Holder**  
**PSI-4-161**  
 Micro Needle Holder  
 19 cm



**Hepp-Scheidel**  
**PSI-4-162-18**  
 Micro Needle Holder smooth jaw  
 18 cm

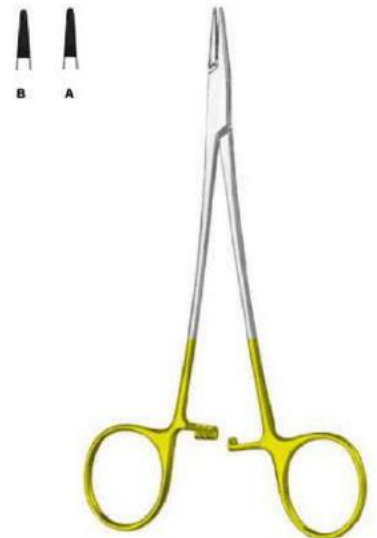

**Webster**  
**PSI-4-163-13**  
 Needle Holder with automatic release ratchet  
 also for lefthanders  
 Fig.233, 16 cm , 12 cm, 13cm, 15 cm



**Micro Needle Holder**

**PSI-4-164-15**

Micro Needle Holder  
15 cm, 18 cm, 21cm, 23 cm



**JABOMA**

**PSI-4-165-18**

Micro Needle Holder  
18 cm



**Castroviejo**

**PSI-4-166**

Micro Needle Holder  
Fig.233, 16 cm , 12 cm, Fig.18 L, 14.5 cm , 18 cm,  
21cm



**Arruga**

**PSI-4-167**

Needle Holder  
Fig.233, 16 cm , 12 cm, Fig.18 L, 16 cm



**Castroviejo**

**PSI-4-168-13**

Micro Needle Holder  
12.5 cm

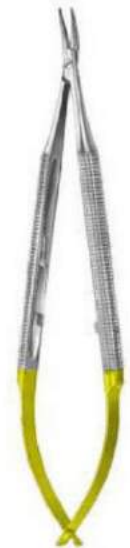

**Barraquer**

**PSI-4-169-13**

13 cm



**Barraquer**  
**PSI-4-170-13**  
 Micro Needle Holder  
 13 cm



**Webster**  
**PSI-4-171-13**  
 Needle Holder  
 13 cm

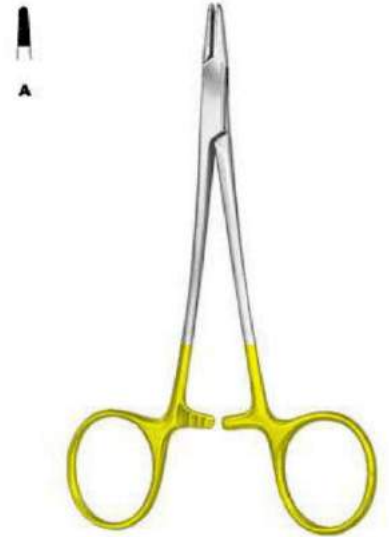

**Derf**  
**PSI-4-173-12**  
 Needle Holder  
 12 cm

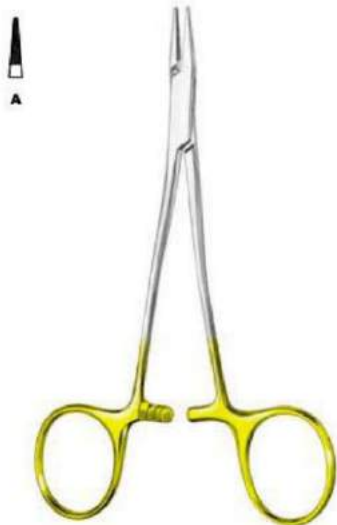

**Kilner**  
**PSI-4-172-13**  
 Needle Holder  
 13 cm



**Hegar-Baumgartner**  
**PSI-4-174-13**  
 Needle Holder  
 13 cm , 14.5 cm



**Halsey**  
**PSI-4-175-12**  
 Needle Holder  
 13 cm , 12 cm



**Crile-Wood**

**PSI-4-176-15**

Needle Holder

15 cm



**Sarot**

**PSI-4-177-18**

Needle Holder

18 cm, 20 cm, 26 cm

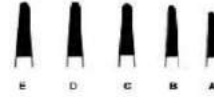

**Mayo-Hegar**

**PSI-4-178-16**

Needle Holder standard profile

16 cm, 18 cm, 20 cm, 24 cm, 26 cm, 30 cm



**Heaney**

**PSI-4-179-20**

Needle Holder

20 cm, 24 cm, 26 cm



**DeBakey**

**PSI-4-180-18**

Needle Holder delicate pattern mini profile

18 cm, 20 cm, 23 cm, 26 cm, 31 cm



**Masson**

**PSI-4-181-27**

Needle Holder

26.5 cm



**Schmieden-Taylor**

**PSI-5-275-17**

Dura Scissors

15 cm



**Strully**

**PSI-5-276-22**

Neurosurgical Scissors

22.5 cm



**Toennis-Adson**

**PSI-5-277-17**

Dissecting Scissors

17.5 cm



**Good**

**PSI-5-279-19**

Tonsil Scissors

19.5 cm



**Fomon**

**PSI-5-282-15**

Nasal Scissors

15 cm



**Cottle**

**PSI-5-283-16**

Nasal Scissors

16 cm



**Ryder (Martin)**

**PSI-4-182-13**

Needle Holder

12.5 cm, 15 cm, 18 cm, 20 cm, 23 cm, 26 cm



**Martin**

**PSI-4-183-15**

Needle Holder mini profile elastic type

15 cm, 17 cm, 20 cm



**Wangensteen**

**PSI-4-184-27**

Needle Holder standard profile

27 cm



**Hegar-Vascular**

**PSI-4-185-14**

Needle Holder micro profile

14 cm, 18.5 cm, 20.5 cm, 23 cm

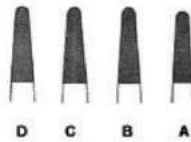

**Bozemann**

**PSI-4-186-20**

Needle Holder standard profile

20.5 cm, 24 cm, 26.5 cm, 29 cm



**Hegar**

**PSI-4-187-20**

Needle Holder standard profile

20 cm, 23.5 cm

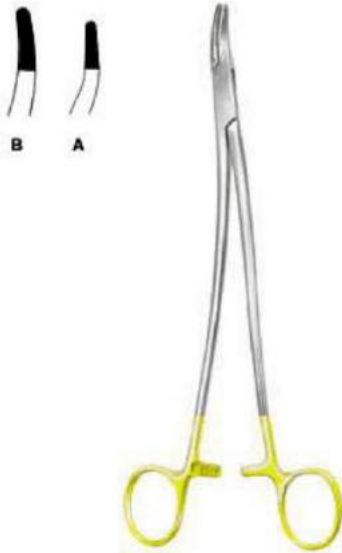

**Stratte**

**PSI-4-188-22**

Needle Holder standard profile  
23 cm



**Microvascular**

**PSI-4-189-00**

Needle Holder slender pattern micro profile  
14 cm, 17.5 cm, 20 cm, 23 cm



**Mathieu**

**PSI-4-190-14**

Needle Holder  
14 cm, 17 cm, 20 cm



**Mathieu**

**PSI-4-191-14**

Needle Holder  
14 cm, 17 cm, 20 cm



**Mathieu**

**PSI-4-192-17**

Needle Holder standard profile with interior  
ratchet  
17 cm, 20 cm, 23 cm



**Toennis**

**PSI-4-193-18**

Needle Holder  
18.5 cm



**Schmieden-Dick**

**PSI-4-201-01**

Ligature Needle malleable  
29 cm

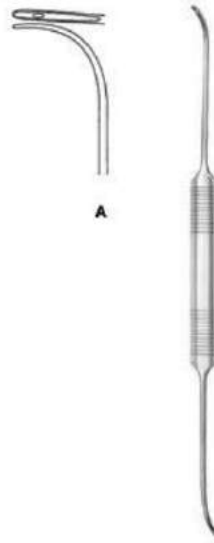

**Schmieden**

**PSI-4-202-21**

Ligature Needle  
24 cm



**Ligature Needle Malleable**

**PSI-4-203-20**

Ligature Needle malleable  
20.5 cm

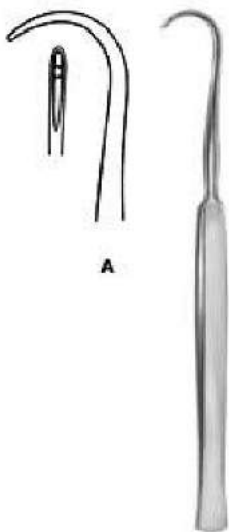

**Cooper**

**PSI-4-204-19**

Ligature Needle  
18.5 cm



**Kronecker**

**PSI-4-205-13**

Ligature Needle delicate for right hand  
12.5 cm

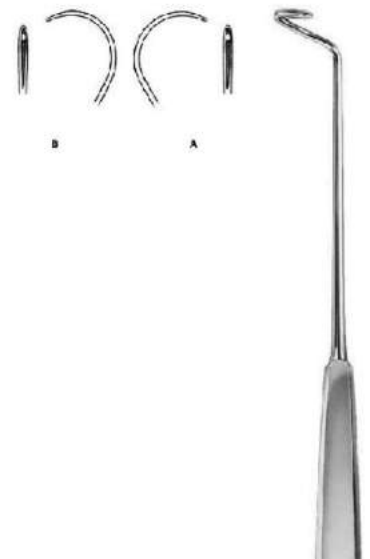

**Deschamps**

**PSI-4-206-24**

24 cm



**Deschamps**

**PSI-4-207-20**

Ligature Needle blunt for right hand  
20 cm



**Deschamps**

**PSI-4-208-20**

Ligature Needle sharp for right hand  
20 cm

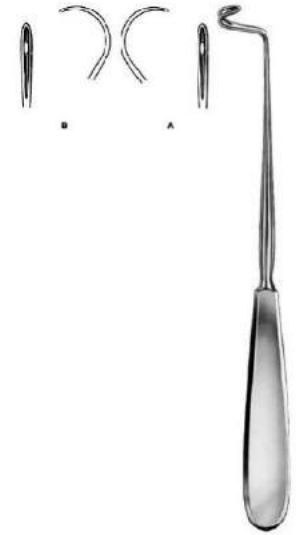

**Deschamps**

**PSI-4-209-21**

Ligature Needle blunt for right hand  
20 cm



**Deschamps**

**PSI-4-210-21**

Ligature Needle sharp for right hand  
20 cm

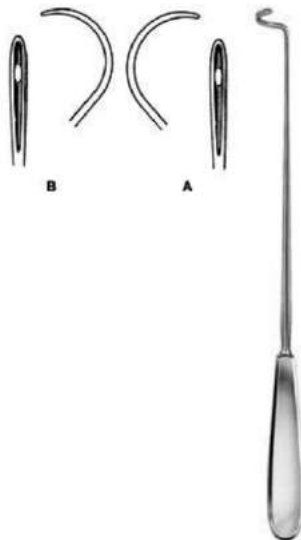

**Deschamps**

**PSI-4-211-27**

Ligature Needle blunt for right hand  
27 cm

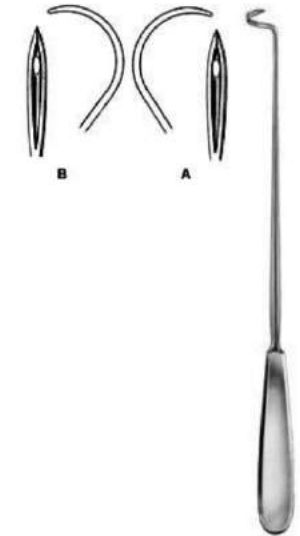

**Deschamps**

**PSI-4-212-27**

Ligature Needle sharp for right hand  
27 cm

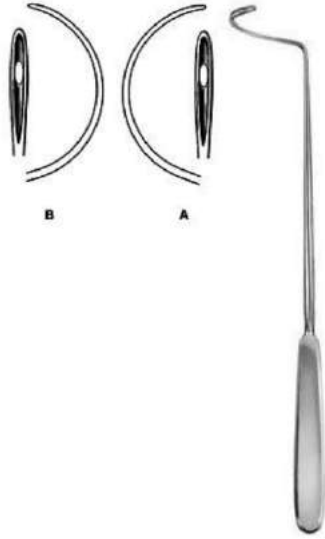

**Deschamps**

PSI-4-213-28

28 cm



**Deschamps**

PSI-4-214-20

Ligature Needle sharp for right hand

20 cm



**Deschamps**

PSI-4-215-20

Ligature Needle blunt for right hand

20 cm



**Deschamps**

PSI-4-216-20

Ligature Needle blunt for right hand

21 cm

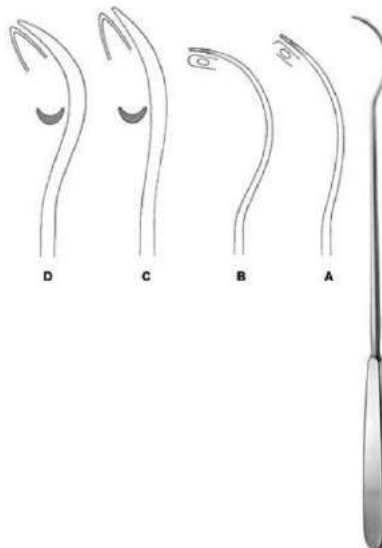

**Brunner**

PSI-4-217-30

Ligature Needle

21 cm



**Kirschner**

PSI-4-218-25

Ligature Conductor

25.5 cm



**Ligature Conductor**

**PSI-4-219-28**

Ligature Conductor  
28 cm



**Modell Wien**

**PSI-4-220-23**

Ligature Catcher  
23.5 cm



**Michel**

**PSI-4-221-12**

Clip Applying Forceps  
12 cm



**Hegenbarth**

**PSI-4-222-12**

Clip Applying Forceps  
12 cm



**Dissecting Knife**

**PSI-5-101-01**

D

15 cm, 15.5 cm, 16 cm , 17 cm



**Autopsy Knife**

**PSI-5-102-10**

A

25.5 cm

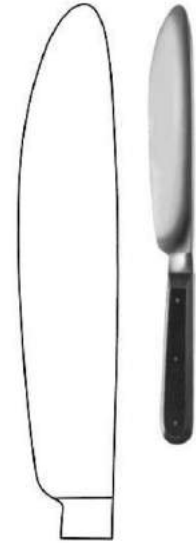

**Walb**

**PSI-5-104-17**

Post Mortem Knife<

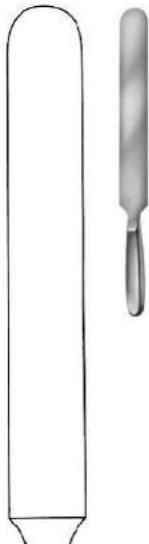

**Virchow**

**PSI-5-105-20**

28.5 cm, 33.5 cm, 38 cm



**Scalpel Handle**

**PSI-5-108-04**

Scalpel Handle

13.5 cm



**Scalpel Handle**

**PSI-5-109-34**

Scalpel Handle

16 cm



**Scalpel Handle**

**PSI-5-110-41**

Scalpel Handle

21cm



**Scalpel Handle**

**PSI-5-111-45**

Scalpel Handle

21cm



**Collin**

**PSI-5-112-08**

Scalpel Handle wit

13.5 cm



**Collin**

**PSI-5-113-09**

S

14.5 cm



**Scalpel Handle**

**PSI-5-114-03**

S

12 cm



**Scalpel Handle**

**PSI-5-115-04**

S

12 cm



**Scalpel Handle**

PSI-5-116-05

S

12 cm



**Scalpel Handle**

PSI-5-117-31

S

21.5 cm



**Scalpel Handle**

PSI-5-118-35

S

21cm



**Scalpel Handle**

PSI-5-119-07

S

16 cm



**Scalpel Handle**

PSI-5-120-71

S

12.5 cm



**Scalpel Handle**

PSI-5-121-03

S

15.5 cm



**Amputation Knife**

PSI-5-127-16

A

29 cm



**Amputation Knife**

PSI-5-128-19

A

32.5 cm



**Catlin**

PSI-5-129-16

I

29 cm



**Resection Knife**

PSI-5-130-06

R

18 cm



**Langenbeck**

PSI-5-131-05

R

18 cm



**Langenbeck**

PSI-5-132-05

I

18 cm

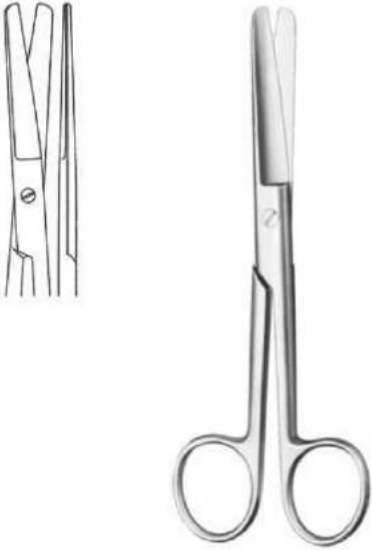

**Standard BL / BL Straight**

**PSI-5-201-13**

Operating Scissor Special Price: \$1.25

12 cm, 13cm, 14.5 cm , 16.5 cm , 18.5 cm , 20.5 cm



**Standard SH / BL STR**

**PSI-5-202-13**

Operating Scissors

12 cm, 13cm, 14.5 cm , 16.5 cm , 18.5 cm , 20.5 cm

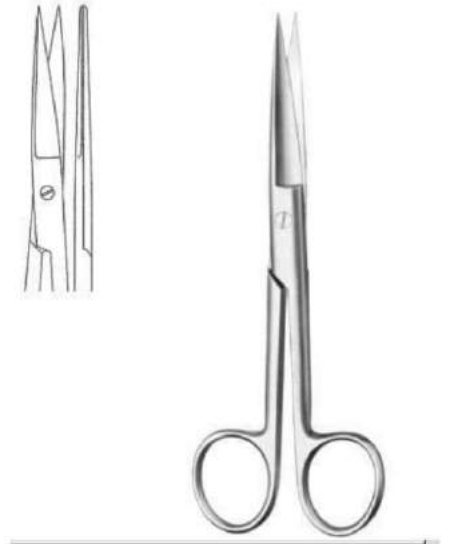

**Standard SH / SH STR**

**PSI-5-204-13**

Operating Scissors

12 cm, 13cm, 14.5 cm , 16.5 cm



**Standard BL / BL Curved**

**PSI-5-205-13**

Operating Scissors

12 cm, 13cm, 14.5 cm , 16.5 cm , 18.5 cm , 20.5 cm

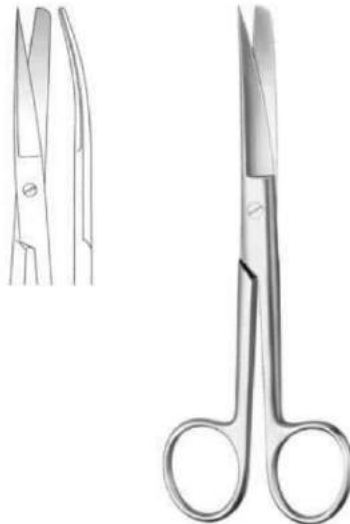

**Standard SH / BL Curved**

**PSI-5-206-13**

Operating Scissors

12 cm, 13cm, 14.5 cm , 16.5 cm , 18.5 cm , 20.5 cm



**Standard SH / SH Curved**

**PSI-5-207-13**

Operating Scissors

12 cm, 13cm, 14.5 cm , 16.5 cm



**Standard BL / BL Curved**

**PSI-5-208-14**

Operating Scissors delicate  
14.5 cm



**Incision Scissor**

**PSI-5-209-14**

Operating Scissor  
14.5 cm



**Deaver**

**PSI-5-210-14**

Operating Scissor



**Mayo**

**PSI-5-211-15**

Dissecting Scissors  
14.5 cm , 15 cm , 17 cm , 23.5 cm



**Mayo**

**PSI-5-212-23**

Dissecting Scissors  
23 cm , 22.5 cm , 28 cm



**Mayo-Harrington**

**PSI-5-213-22**

Dissecting Scissors  
23 cm , 22.5 cm , 28 cm

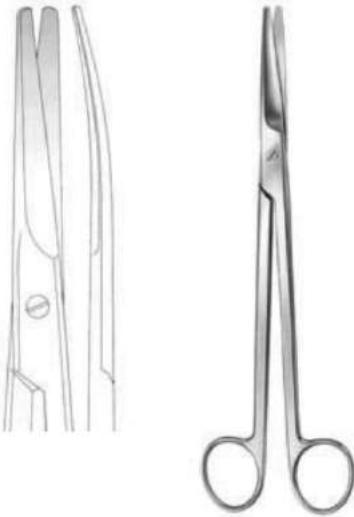

**Mayo-Harrington**

**PSI-5-214-22**

Dissecting Scissors cur  
22.5 cm, 23 cm, 28 cm

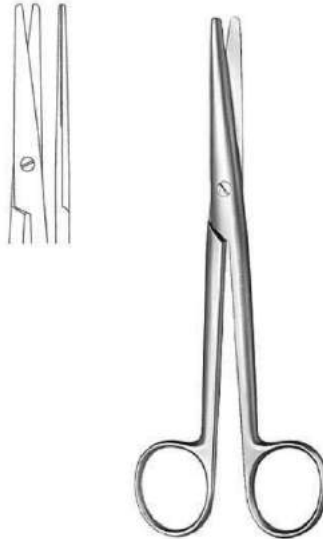

**Mayo-Stille**

**PSI-5-215-17**

Dissecting Scissors str  
15 cm, 17 cm

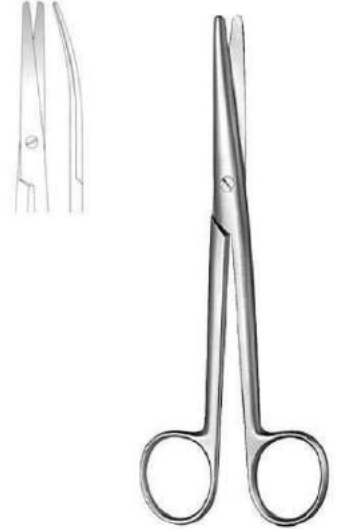

**Mayo-Stille**

**PSI-5-216-15**

Dissecting Scissors cur  
15 cm, 17 cm

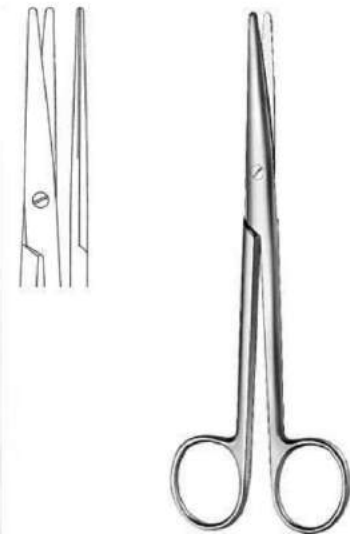

**Mayo-Stille**

**PSI-5-217-19**

Dissecting Scissors cur  
16 cm, 19.5 cm, 21.5 cm

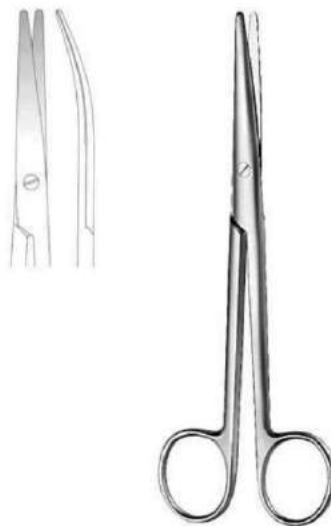

**Mayo-Stille**

**PSI-5-218-16**

Dissecting Scissors cur  
16 cm, 19.5 cm, 21.5 cm



**Mayo-Noble**

**PSI-5-219-17**

Gynecological Scissors  
16.5 cm



**Lexer**  
**PSI-5-238-16**  
Dissecting Scissors  
16 cm

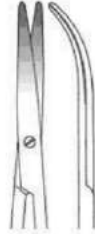

**Cinelli**  
**PSI-5-239-14**  
Nasal Scissors  
11.5cm, 14 cm



**Thorek**  
**PSI-5-240-19**  
Dissecting Scissors  
18.5 cm



**Lexer-Baby**  
**PSI-5-241-10**  
Dissecting Scissors  
10 cm



**Lexer-Fino**  
**PSI-5-242-16**  
Delicate Dissecting Scissors slender pattern  
16.5 cm



**Metzenbaum-Fino**  
**PSI-5-243-14**  
Delicate Dissecting Scissors slender pattern  
14.5 cm



**Metzenbaum-Fino**

**PSI-5-244-14**

Delicate Dissecting Scissors

14.5 cm



**Metzenbaum-Fino**

**PSI-5-245-14**

Delicate Dissecting Scissors

14.5 cm



**Metzenbaum-Fino**

**PSI-5-246-14**

Delicate Dissecting Scissors

14.5 cm

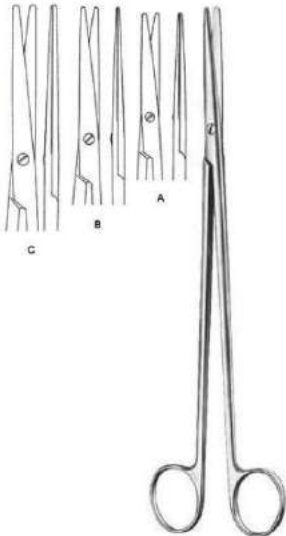

**Metzenbaum-Fino**

**PSI-5-247-18**

Delicate Dissecting Scissors slender pattern

18 cm, 20cm, 23 cm

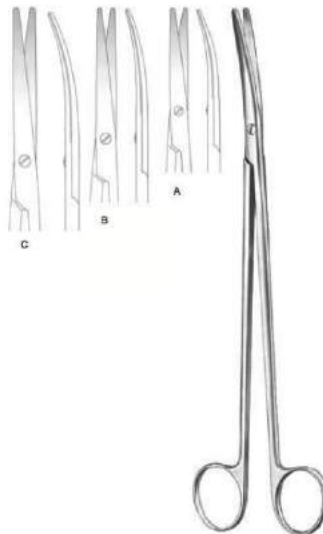

**Metzenbaum-Fino**

**PSI-5-248-18**

Delicate Dissecting Scissors slender pattern

18 cm, 20cm, 23 cm

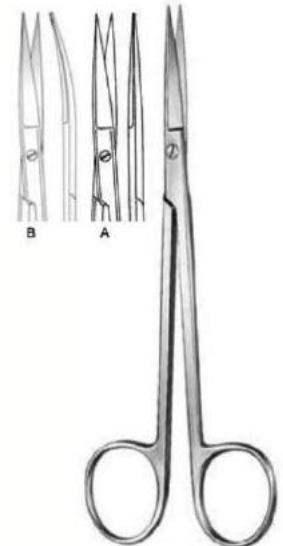

**Sanvenero**

**PSI-5-250-14**

Operating Scissors

14 cm



**Lexer**  
**PSI-5-238-16**  
Dissecting Scissors  
16 cm



**Cinelli**  
**PSI-5-239-14**  
Nasal Scissors  
11.5cm, 14 cm



**Thorek**  
**PSI-5-240-19**  
Dissecting Scissors  
18.5 cm



**Lexer-Baby**  
**PSI-5-241-10**  
Dissecting Scissors  
10 cm



**Lexer-Fino**  
**PSI-5-242-16**  
Delicate Dissecting Scissors slender pattern  
16.5 cm



**Metzenbaum-Fino**  
**PSI-5-243-14**  
Delicate Dissecting Scissors slender pattern  
14.5 cm



**Metzenbaum-Fino**

**PSI-5-244-14**

Delicate Dissecting Scissors  
14.5 cm



**Metzenbaum-Fino**

**PSI-5-245-14**

Delicate Dissecting Scissors  
14.5 cm



**Metzenbaum-Fino**

**PSI-5-246-14**

Delicate Dissecting Scissors  
14.5 cm

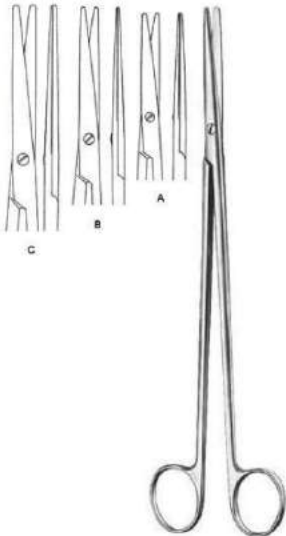

**Metzenbaum-Fino**

**PSI-5-247-18**

Delicate Dissecting Scissors slender pattern  
18 cm, 20cm, 23 cm

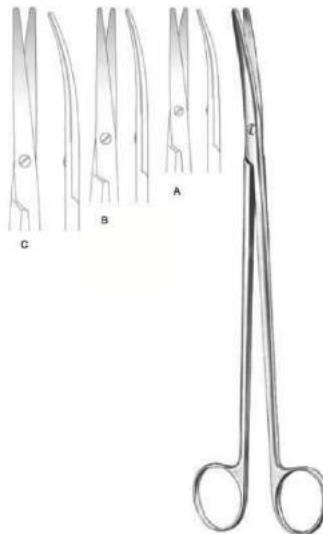

**Metzenbaum-Fino**

**PSI-5-248-18**

Delicate Dissecting Scissors slender pattern  
18 cm, 20cm, 23 cm

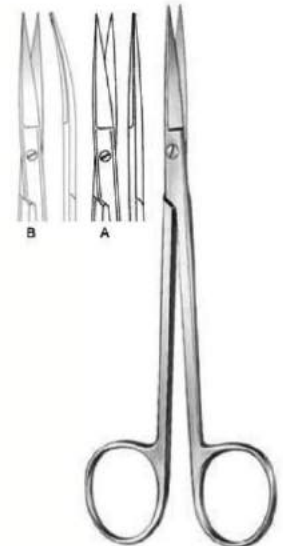

**Sanvenero**

**PSI-5-250-14**

Operating Scissors  
14 cm

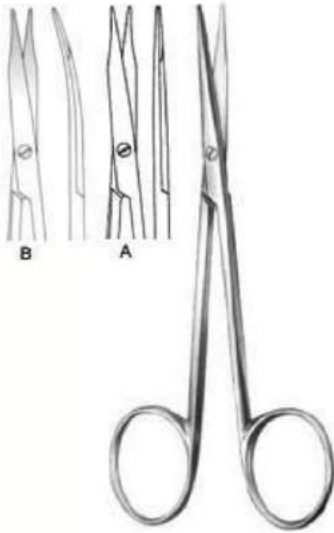

**Fine Operating Scissors**

**PSI-5-251-11**

Fine Operating Scissors  
11.5cm

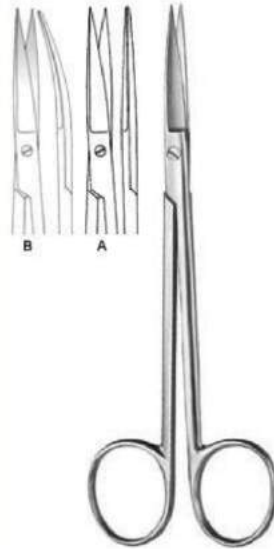

**Joseph**

**PSI-5-252-14**

Operating Scissors  
14.5 cm

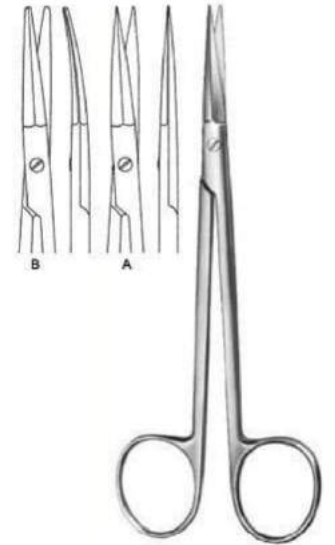

**Peck-Joseph**

**PSI-5-253-14**

Face-lift Scissors  
14.5 cm

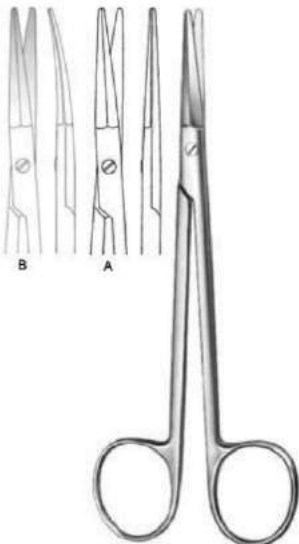

**Peck-Joseph**

**PSI-5-254-14**

Face-lift Scissors  
14.5 cm



**Shea Vein Graft**

**PSI-5-255-12**

Dissecting Scissors  
12 cm

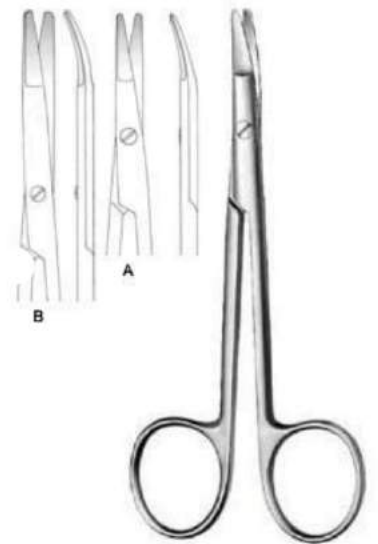

**Kilner**

**PSI-5-256-12**

Dissecting Scissors  
12 cm, 15 cm

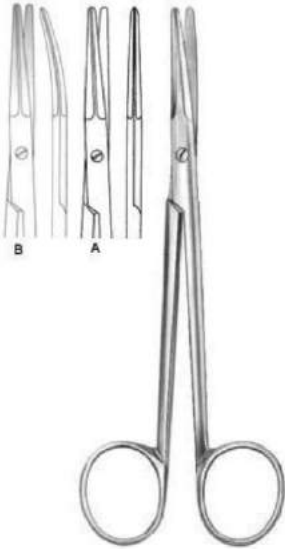

**Dissecting Scissors**

**PSI-5-257-14**

14.5 cm

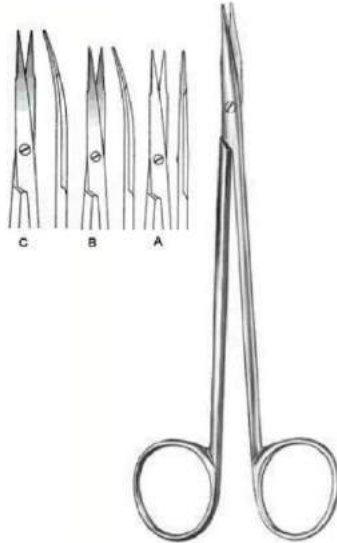

**Reynolds**

**PSI-5-258-15**

Dissecting Scissors

15.5 cm, 18 cm



**Jameson**

**PSI-5-259-14**

Dissecting Scissors

15.5 cm



**Jameson**

**PSI-5-260-14**

Dissecting Scissors

15.5 cm



**Vascular Scissors**

**PSI-5-261-19**

19 cm

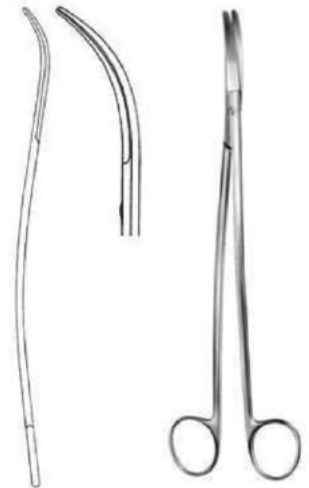

**Vascular Scissors**

**PSI-5-262-24**

19 cm , 25.5 cm

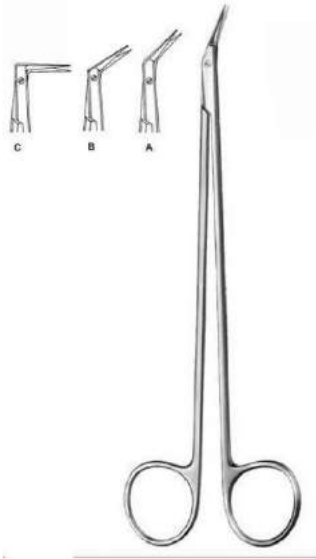

**Diethrich**

**PSI-5-263-25**

vascular Scissors

17.5 cm, 18.5 cm, 19 cm



**DeBakey**

**PSI-5-264-45**

vascular Scissors

16 cm, 16.5 cm

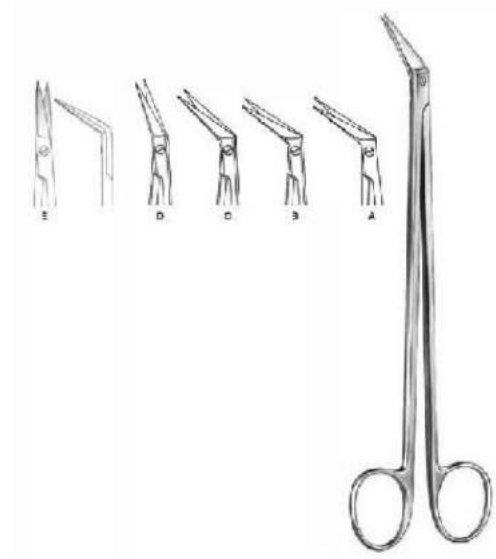

**Potts-Smith**

**PSI-5-265-19**

Vascular Scissors

18 cm, 18.5 cm, 19 cm



**Coronary Scissors**

**PSI-5-267-45**

Cardiovascular Surgery Scissors

18 cm



**Coronary Scissors**

**PSI-5-267-45**

Cardiovascular Surgery Scissors

18 cm



**Coronary Scissors**

**PSI-5-268-60**

18 cm



**Schmieden-Taylor**

**PSI-5-275-17**

Dura Scissors

15 cm



**Strully**

**PSI-5-276-22**

Neurosurgical Scissors

22.5 cm



**Toennis-Adson**

**PSI-5-277-17**

Dissecting Scissors

17.5 cm



**Good**

**PSI-5-279-19**

Tonsil Scissors

19.5 cm



**Fomon**

**PSI-5-282-15**

Nasal Scissors

15 cm



**Cottle**

**PSI-5-283-16**

Nasal Scissors

16 cm



**Modell USA**

**PSI-5-290-10**

Umbilical Scissors

10.5 cm



**Busch**

**PSI-5-292-16**

Umbilical Scissors

16 cm



**Goldmann-Fox**

**PSI-5-293-13**

Gum Scissors

13cm



**Wagner**

**PSI-5-294-12**

Operating Scissors

12 cm

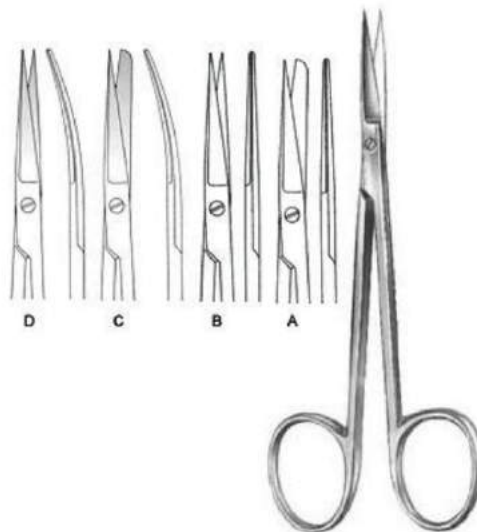

**Operating Scissors**

**PSI-5-295-12**

Operating Scissors small model

12 cm



**La Grange**

**PSI-5-296-11**

Gum Scissors S-shaped

11.5cm



**Dissecting Scissors**

**PSI-5-297-11**

Dissecting Scissors 11.5cm  
11.5cm



**Locklin**

**PSI-5-298-16**

Gum Scissors 16cm  
16 cm



**Locklin**

**PSI-5-299-16**

Gum Scissors  
16 cm



**Operating Scissors**

**PSI-5-300-08**

9

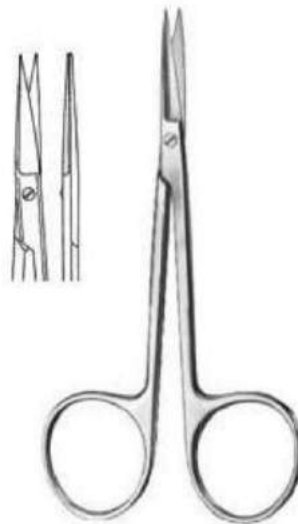

**Iris Scissors**

**PSI-5-301-10**

9 cm, 10 cm

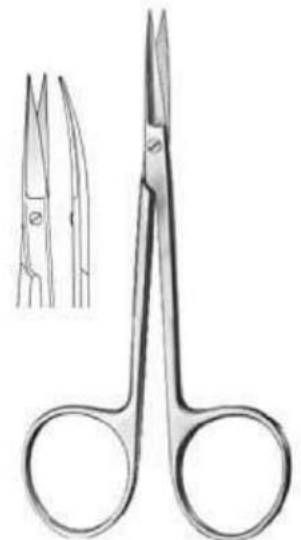

**Iris Scissors**

**PSI-5-302-10**

10 cm



**Iris Scissors**

PSI-5-303-10

10 cm



**Bonn**

PSI-5-304-09

Iris Scissors



**Dean**

PSI-5-278-17

Tonsil Scissors 17.5cm

17.5 cm



**Spencer Scissor**

PSI-0-

Spencer Scissor



**Standard**

**PSI-5-401-10**

Dressing Forceps

18.5 cm , 18.5 cm , 13cm, 14.5 cm , 16 cm, 18 cm, 20cm, 23 cm , 25 cm , 30.5 cm



**Standard**

**PSI-5-402-11**

Dressing Forceps

12 cm, 13cm, 14.5 cm , 16 cm, 18 cm, 20cm, 25 cm , 30 cm



**Dressing Forceps**

**PSI-5-403-13**

D

13cm, 14.5 cm



**Stille**

**PSI-5-404-15**

Dressing Forceps

15 cm



**Mini-Adson**

**PSI-5-405-12**

Dressing Forceps

12 cm



**Adson**

**PSI-5-406-12**

Dressing Forceps

12 cm, 15 cm



**McIndoe**

**PSI-5-405-12**

Dressing Forceps

15 cm



**Waugh**

**PSI-5-408-20**

Dressing Forceps

20cm



**Semken**

**PSI-5-409-12**

Dressing Forceps

12.5 cm, 15 cm



**Taylor**

**PSI-5-410-17**

Dressing Forceps

12.5 cm, 15 cm



**Taylor**

**PSI-5-411-17**

Dressing Forceps

17 cm



**Taylor**

**PSI-5-412-17**

Dressing Forceps

18.5 cm



**Dressing Forceps**

**PSI-5-413-06**

Dressing Forceps

15.5 cm



**Gerald**

**PSI-5-414-18**

Dressing Forceps

15.5 cm



**Cushing**

**PSI-5-415-17**

Dressing Forceps

17.5 cm



**Potts-Smith**

**PSI-5-416-18**

Dressing Forceps

18 cm, 21cm, 24.5 cm



**Bonney**

**PSI-5-417-17**

Dissecting Forceps

17.5 cm



**Gerald**

**PSI-5-418-17**

17.5 cm



**Gillies**

**PSI-5-419-15**

Dissecting Forceps  
15.5 cm



**McIndoe**

**PSI-5-420-15**

Dissecting Forceps  
15 cm



**Semken**

**PSI-5-421-16**

Dissecting Forceps  
15.5 cm, 17.5 cm



**Adson-Brown**

**PSI-5-422-12**

Dissecting Forceps  
12 cm



**Adson**

**PSI-5-423-12**

Dissecting Forceps  
12 cm, 15 cm



**Adson**

**PSI-5-424-12**

Dressing Forceps  
12 cm, 15 cm



**Cushing**

PSI-5-425-17

Dressing Forceps

17.5 cm



**Cushing**

PSI-5-426-18

Dressing Forceps

17 cm



**Cushing-Taylor**

PSI-5-427-18

Dressing Forceps

18.5 cm



**Potts-Smith**

PSI-5-428-15

Dressing Forceps

16 cm, 18.5 cm, 20cm, 23 cm, 25 cm



**Oehler**

PSI-5-429-14

Dissecting Forceps

14.5 cm, 16 cm, 18 cm, 20cm, 25 cm



**Wangensteen**

PSI-5-430-15

Dressing Forceps

15 cm, 23 cm



**Dissecting Forceps**

**PSI-5-437-13**

Dissecting Forceps

13 cm , 14.5 cm , 16 cm, 20cm



**Dissecting Forceps**

**PSI-5-438-13**

Dissecting Forceps

13 cm , 14.5 cm



**Stille**

**PSI-5-439-15**

Dissecting Forceps

15 cm



**Stille**

**PSI-5-440-15**

Dissecting Forceps

15 cm



**Stone**

**PSI-5-441-15**

Dissecting Forceps

15 cm



**Lerche**

**PSI-5-442-15**

Dissecting Forceps

15 cm



**Taylor**

**PSI-5-449-17**

Dissecting Forceps

17 cm



**Taylor**

**PSI-5-450-17**

Dissecting Forceps

18.5 cm



**Dissecting Forceps**

**PSI-5-451-06**

Dissecting Forceps

15.5 cm



**Gerald**

**PSI-5-452-17**

Dissecting Forceps

17.5 cm



**Cushing**

**PSI-5-453-17**

Dissecting Forceps

18 cm



**Potts-Smith**

**PSI-5-454-18**

Dissecting Forceps

18 cm, 21cm, 24 cm

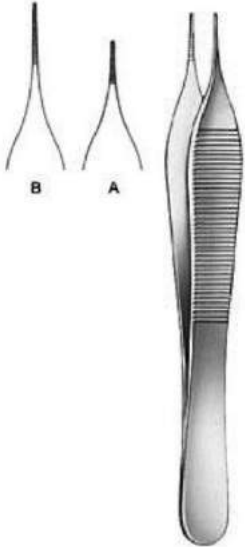

**Mikro-Adson**

**PSI-5-455-12**

Dressing Forceps  
12 cm, 15 cm

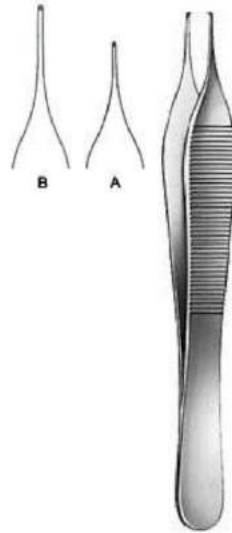

**Mikro-Adson**

**PSI-5-456-12**

Dissecting Forceps  
12 cm, 15 cm



**Dissecting Forceps**

**PSI-5-457-11**

Dissecting Forceps  
10.5 cm



**Micro Jewelers**

**PSI-5-458-12**

Jeweler Type Forceps  
12 cm Fig. 7



**Jewelers**

**PSI-5-459-12**

Jeweler Type Forceps  
12 cm Fig. 3



**Jewelers**

**PSI-5-460-11**

Jeweler Type Forceps  
11 cm Fig. 3c



**Jewelers**

**PSI-5-461-11**

Jeweler Type Forceps

11 cm Fig. 5



**Jewelers**

**PSI-5-462-11**

Jeweler Type Forceps

11 cm Fig. 4



**Stille-Barraya**

**PSI-5-463-18**

Dissecting Forceps

18 cm



**Bonney**

**PSI-5-464-18**

Dissecting Forceps

17.5 cm



**Nelson**

**PSI-5-465-23**

Dissecting Forceps

23 cm

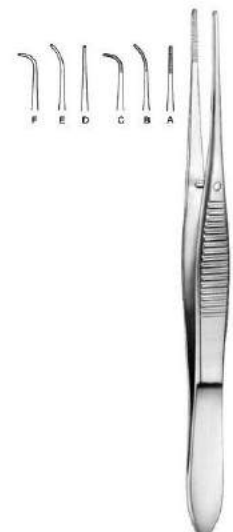

**Dressing Forceps**

**PSI-5-466-10**

Dressing Forceps

10 cm , 9.5 cm



**Splinter Forceps Smooth Jaw**

**PSI-5-467-12**

Splinter Forceps smooth jaw  
12.5 cm



**Splinter Forceps Smooth Jaw**

**PSI-5-468-12**

Splinter Forceps smooth jaw  
12.5 cm



**Splinter Forceps**

**PSI-5-469-12**

Splinter Forceps  
12.5 cm



**Splinter Forceps**

**PSI-5-470-12**

Splinter Forceps  
12.5 cm



**Micro Tying Forceps**

**PSI-5-471-16**

Micro Tying Forceps  
15.5 cm



**Microscopic Forceps Super Light,  
Blunt**

**PSI-5-472-10**

Microscopic Forceps super light, blunt  
10 cm



**Microscopic Forceps**

PSI-5-473-10

Microscopic Forceps

10 cm



**Shaaf**

PSI-5-474-09

Splinter Forceps

9.5 cm



**Littauer**

PSI-5-475-08

Cilia Forceps

8.5 cm



**Cilia Forceps**

PSI-5-476-09

Cilia Forceps

8.5 cm



**Douglas**

PSI-5-477-09

Cilia Forceps

9 cm



**Douglas**

PSI-5-478-09

Cilia Forceps

9 cm



**Beer**

**PSI-5-479-09**

Cilia Forceps

9 cm



**Phaneuf**

**PSI-5-501-21**

Hysterectomy Forceps  
20.5 cm



**Wertheim-Cullen**

**PSI-5-502-21**

Vaginal Clamp  
21 cm

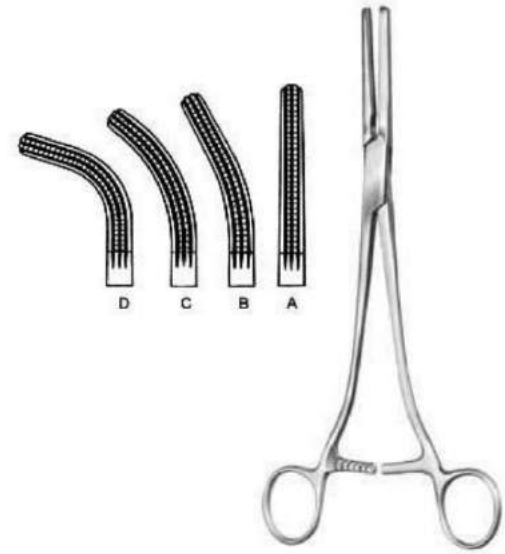

**Rogers**

**PSI-5-503-10**

Hysterectomy Forceps  
21.5 cm Fig. 1, 21 cm Fig. 2, 20.5 cm Fig. 3, 20 cm Fig. 4



**Moynihan**

**PSI-5-504-23**

Hysterectomy Forceps  
23 cm



**Moynihan**

**PSI-5-505-24**

Hysterectomy Forceps  
23.5 cm



**Wertheim**

**PSI-5-506-25**

Hysterectomy Forceps  
26 cm

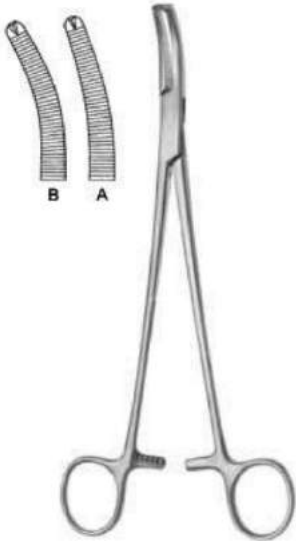

**Wertheim**

**PSI-5-507-22**

Hysterectomy Forceps

22.5 cm



**Mikulicz, Baby**

**PSI-5-508-14**

Peritoneum Forceps

14.5 cm



**Mikulicz**

**PSI-5-509-18**

Peritoneum Forceps

20.5 cm



**Mikulicz**

**PSI-5-510-20**

Peritoneum Forceps

18.5 cm



**Mikulicz**

**PSI-5-511-20**

Peritoneum Forceps

20cm



**Mikulicz**

**PSI-5-512-21**

Peritoneum Forceps

20.5 cm



**Faure**

**PSI-5-513-20**

Peritoneum Forceps

21 cm

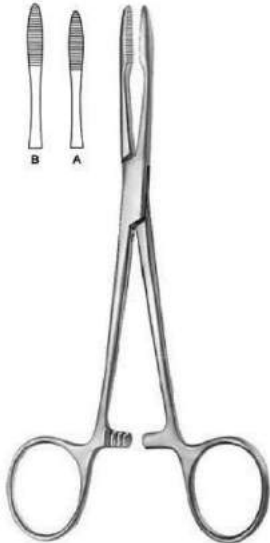

**Pean**

**PSI-5-601-14**

Haemostatic Forceps

14.5 cm , 16 cm

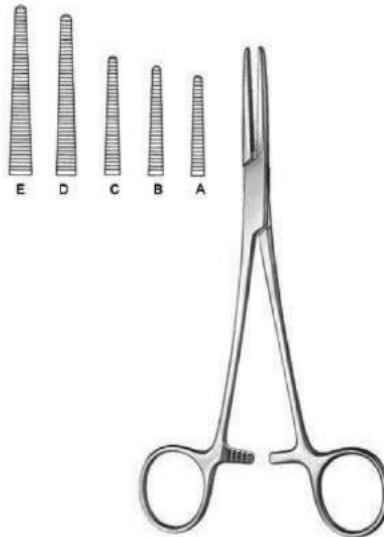

**Spencer-Wells**

**PSI-5-602-13**

Haemostatic Forceps

13 cm , 14 cm , 15.5 cm , 18.5 cm , 20 cm

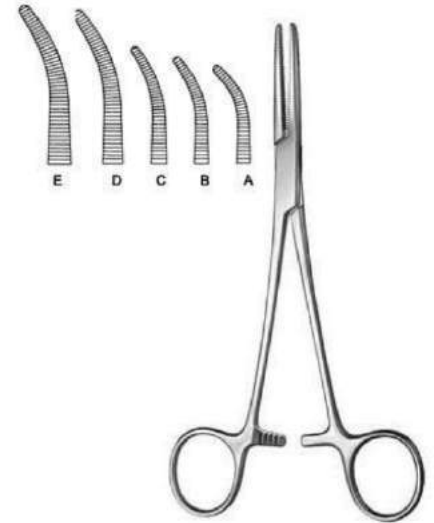

**Spencer-Wells**

**PSI-5-603-13**

Haemostatic Forceps

13 cm , 14 cm , 15 cm , 18 cm , 20 cm



**Chaput**

**PSI-5-604-13**

Haemostatic Forceps

12.5 cm



**Tuffier**

**PSI-5-605-13**

Haemostatic Forceps

12.5 cm



**Grasping Forceps**

**PSI-5-606-25**

Organ Grasping For



**Collin**

**PSI-5-607-14**

Organ Grasping Forceps  
12.5 cm, 21 cm



**Collin**

**PSI-5-608-17**

Tumor Grasping Forceps  
17 cm



**Pennington**

**PSI-5-609-15**

Haemostatic Forceps  
15.5 cm



**Pratt**

**PSI-5-610-15**

Haemostatic Forceps  
15 cm



**Martel-Rees**

**PSI-5-611-14**

Face-lift Forceps  
13.5 cm



**Ligature Forceps**

**PSI-5-612-12**

Ligature Forceps



**Mixer-Baby**

**PSI-5-613-01**

Dissecting and Ligature Forceps

13 cm , 13.5 cm

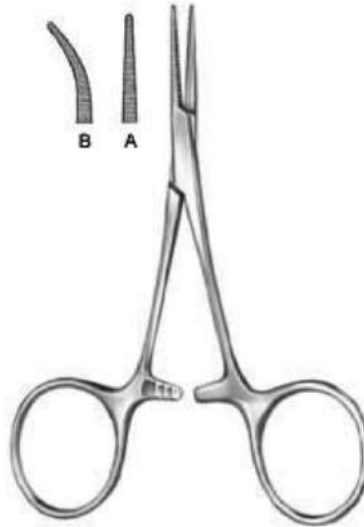

**Hartmann**

**PSI-5-614-10**

Haemostatic Forceps

9.5 cm, 10 cm



**Ligature Forceps**

**PSI-5-615-12**

Ligature Forceps

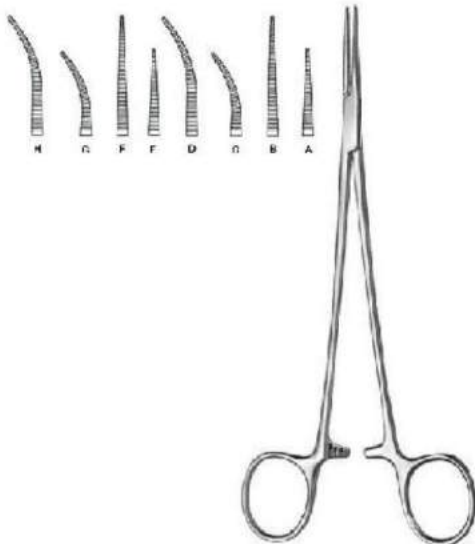

**Halsted-Mosquito**

**PSI-5-616-18**

Haemostatic Forceps

12.5 cm, 14 cm, 14.5 cm

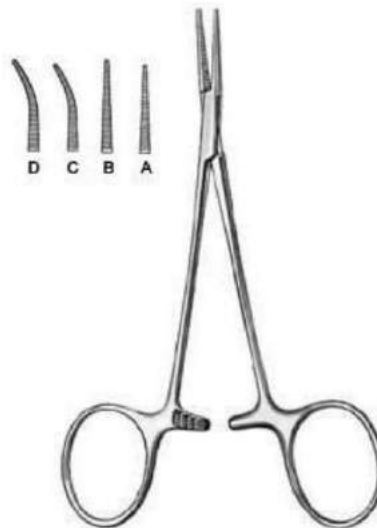

**Mikro-Mosquito**

**PSI-5-617-10**

Haemostatic Forceps

9.5 cm, 10 cm , 11.5 cm, 12 cm



**Providence-Hospital**

**PSI-5-618-14**

Haemostatic Forceps

14 cm



**Lovelace**

**PSI-5-625-15**

Haemostatic Forceps

16 cm



**Dandy-Mosquito**

**PSI-5-626-12**

Haemostatic Forceps

12 cm

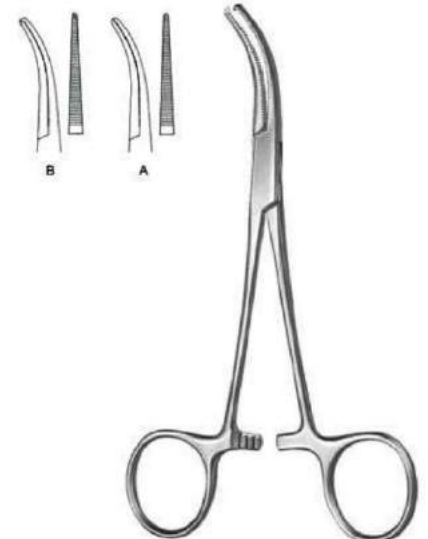

**Dandy**

**PSI-5-627-14**

Haemostatic Forceps

14 cm, 14.5 cm



**Schnidt**

**PSI-5-628-18**

Dissecting and Ligature Forceps

18.5 cm , 19 cm



**Adson**

**PSI-5-629-18**

Dissecting and Ligature Forceps

18.5 cm , 19 cm



**Martin-Fuchsig**

**PSI-5-630-20**

Dissecting and Ligature Forceps

20.5 cm

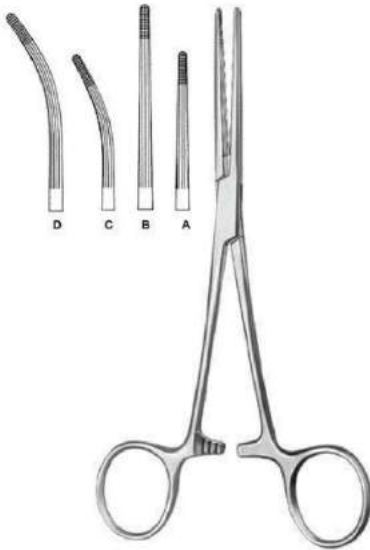

**Rochester-Carmalt**

**PSI-5-631-16**

Haemostatic Forceps

16.5 cm, 17 cm, 20 cm, 20.5 cm

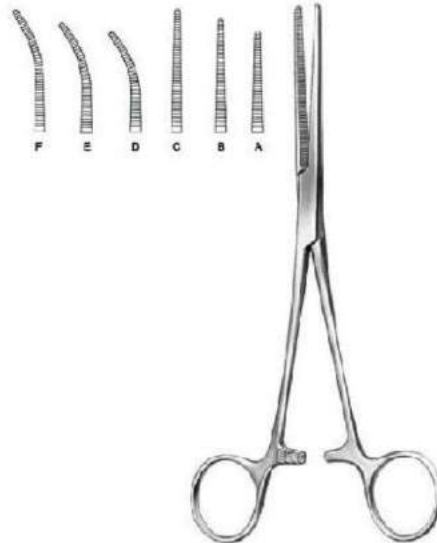

**Pean**

**PSI-5-632-13**

Haemostatic Forceps

13 cm, 13.5 cm, 14 cm, 14.5 cm, 16.5 cm, 17 cm

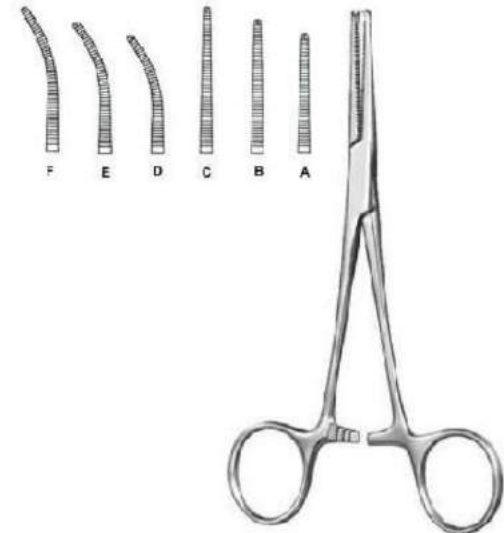

**Kocher-Nippon**

**PSI-5-633-14**

Haemostatic Forceps

14.5 cm, 16 cm, 16.5 cm, 18 cm, 18 cm

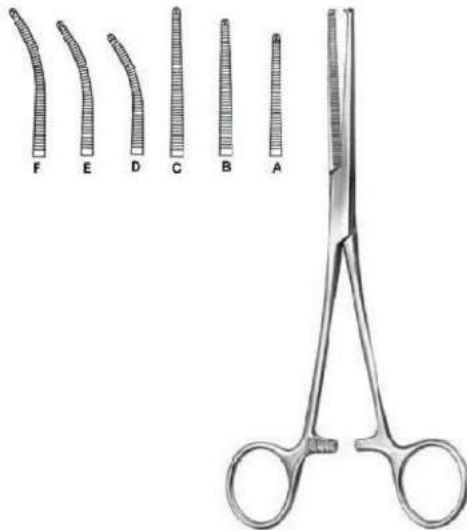

**Kocher**

**PSI-5-635-13**

Haemostatic Forceps

13 cm, 14 cm, 16 cm

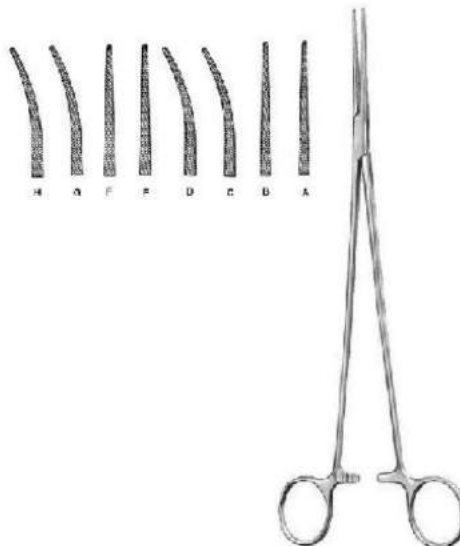

**Bengolea**

**PSI-5-636-20**

Haemostatic Forceps

21 cm, 21.5 cm, 26 cm

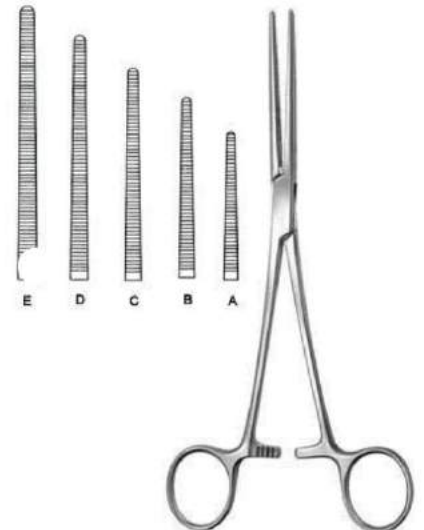

**Pean (Rochester)**

**PSI-5-637-14**

Haemostatic Forceps

14 cm, 14.5 cm, 16 cm, 16.5 cm, 18.5 cm, 20.5 cm, 22.5 cm, 24.5 cm, 26 cm, 30.5 cm

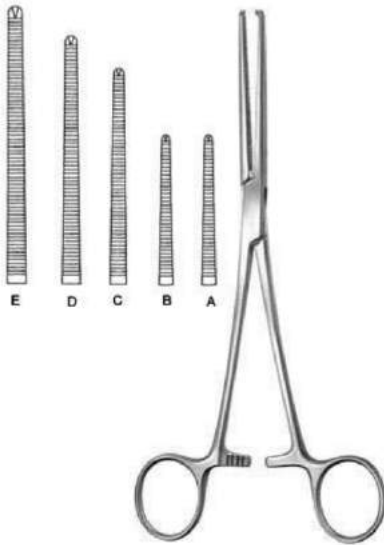

**Kocher (Ochsner)**

**PSI-5-638-14**

Haemostatic Forceps

14.5 cm , 16.5 cm , 18.5 cm , 20.5 cm , 22.5 cm ,  
24.5 cm , 26 cm , 30.5 cm

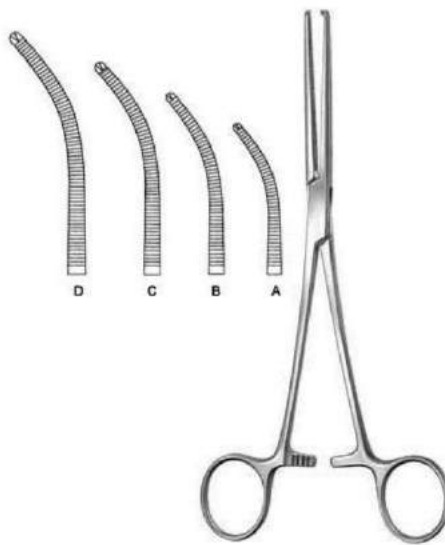

**Kocher (Ochsner)**

**PSI-5-639-14**

Haemostatic Forceps

14 cm , 16 cm , 18 cm , 20 cm , 22 cm , 24 cm , 25.5  
cm , 30 cm

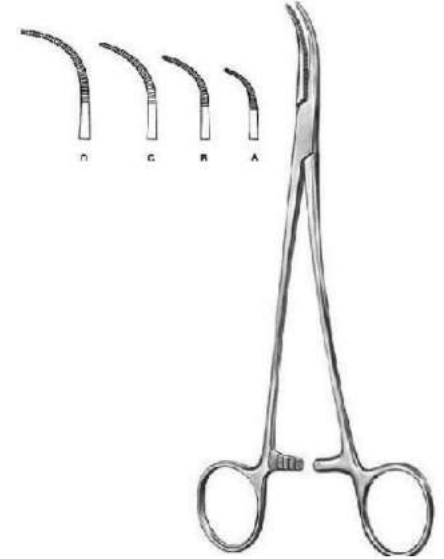

**Overholt-Martin**

**PSI-5-640-01**

Dissecting and Ligature Forceps

18.5 cm Fig. 1 , 20.5 cm Fig. 2 , 21 cm Fig. 3 , 21.5  
cm Fig. 4 , 24.5 cm Fig. 5



**Mixer-Baby**

**PSI-5-641-18**

Dissecting and Ligature Forceps

18.5 cm



**Adson-Baby**

**PSI-5-642-14**

Dissecting and Ligature Forceps

14.5 cm , 18 cm



**Heiss**

**PSI-5-643-20**

Dissecting and Ligature Forceps

20 cm , 20.5 cm , 21 cm



**Overholt-Mixer**

**PSI-5-644-21**

Dissecting and Ligature Forceps  
21.5 cm

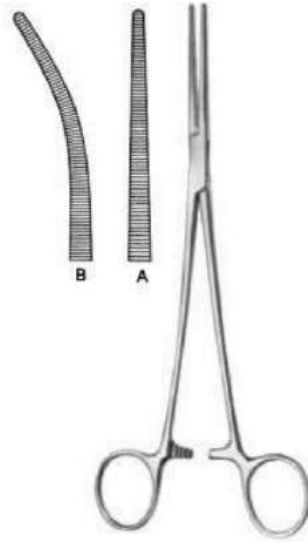

**Roberts**

**PSI-5-645-22**

Dissecting and Ligature Forceps  
21.5 cm, 22.5 cm

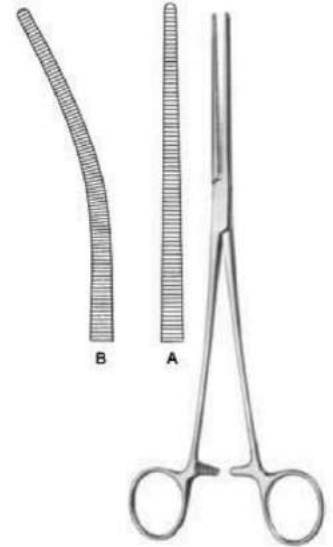

**Sarot**

**PSI-5-646-24**

Dissecting and Ligature Forceps  
24.5 cm, 25 cm

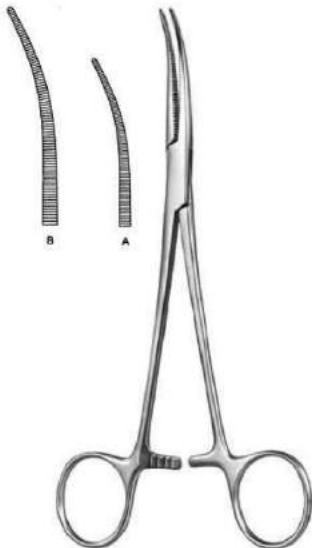

**Crafoord**

**PSI-647-18**

Dissecting and Ligature Forceps  
18 cm, 24.5 cm

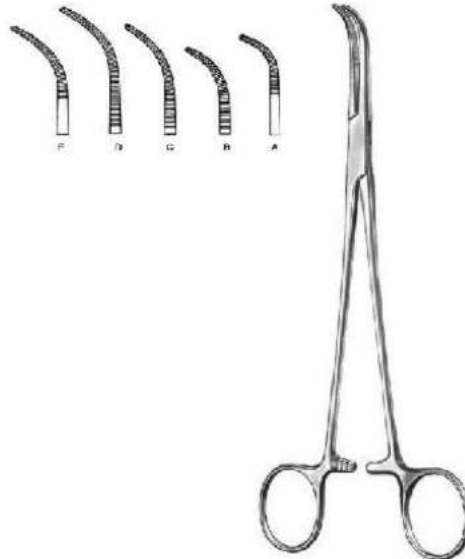

**Overholt-Geissendorfer**

**PSI-5-648-01**

Dissecting and Ligature Forceps  
20.5 cm Fig. 1, 20 cm Fig. 2, 21.5 cm Fig. 3, 22 cm Fig. 4, 21.5 cm Fig. 5, 22 cm Fig. 6, 27 cm Fig. 1, 26.5 cm Fig. 2, 27.5 cm Fig. 3, 28 cm Fig. 4

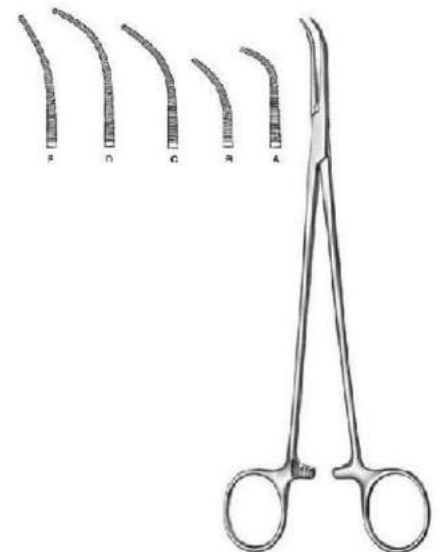

**Overholt-Fino**

**PSI-5-649-00**

Dissecting and Ligature Forceps  
21 cm, 21.5 cm, 22 cm, 22.5 cm, 23 cm

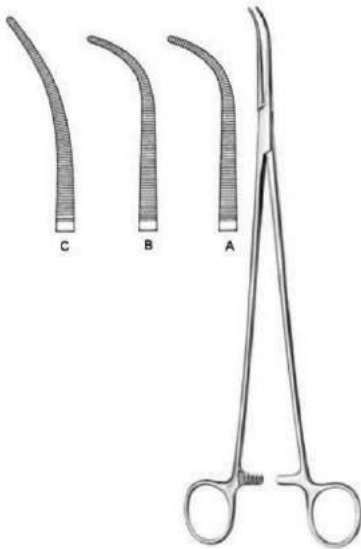

**Overholt**

**PSI-5-650-00**

Dissecting and Ligature Forceps  
29.5 cm, 30 cm



**Overholt-Mini**

**PSI-5-651-01**

Dissecting and Ligature Forceps  
15 cm, 20 cm

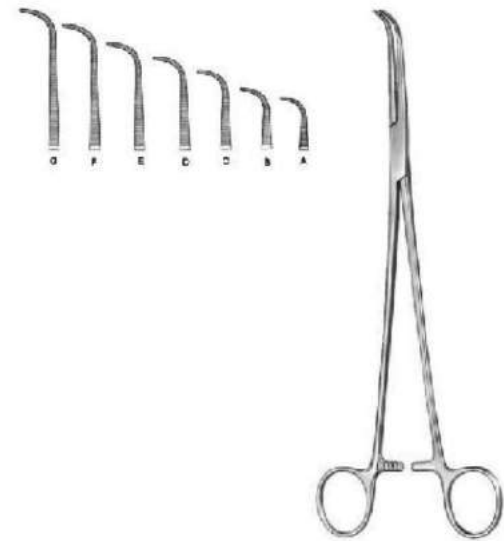

**Gemini**

**PSI-5-652-13**

Dissecting and Ligature Forceps  
13 cm, 16 cm, 18 cm, 21 cm, 23 cm, 25 cm, 28 cm

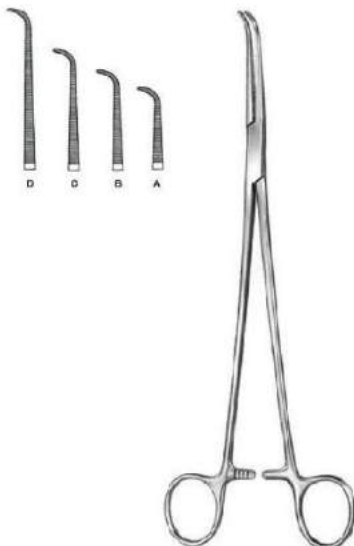

**Mini-Gemini**

**PSI-5-653-18**

Dissecting and Ligature Forceps  
18 cm, 22.5 cm, 25 cm, 28.5 cm

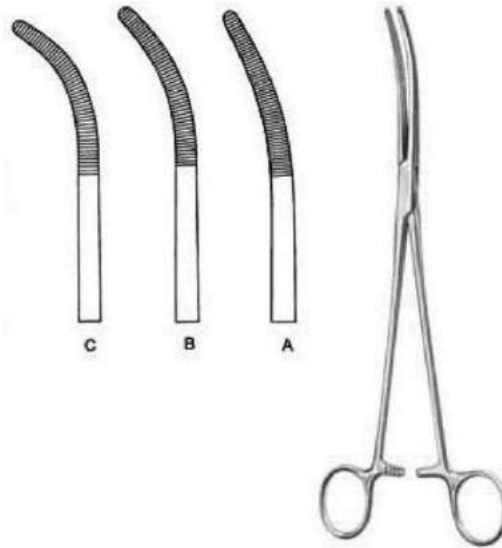

**Rumel**

**PSI-5-654-01**

Dissecting and Ligature Forceps  
24 cm Fig. 1, 23.5 cm Fig. 2, 23 cm Fig. 3, 24 cm Fig. 4, 23.5 cm Fig. 5



**Zenker**

**PSI-5-655-01**

Dissecting and Ligature Forceps  
28.5 cm, 29.5 cm



**Mixer-Baby**

PSI-5-656-14

Dissecting and Ligature Forceps

13.5 cm



**Mixer**

PSI-5-657-15

Dissecting and Ligature Forceps

16 cm, 18 cm



**Mixer-O Shaugnessy**

PSI-5-658-19

Dissecting and Ligature Forceps

18 cm



**Mixer**

PSI-5-659-22

Dissecting and Ligature Forceps

22.5 cm



**Mixer**

PSI-5-660-23

Dissecting and Ligature Forceps

23 cm



**Wickstrom**

PSI-5-661-21

Dissecting and Ligature Forceps

21 cm, 24.5 cm



**Mixer**

**PSI-5-662-22**

Dissecting and Ligature Forceps  
22.5 cm, 26 cm, 28 cm



**Mc Quigg-Mixter**

**PSI-5-663-22**

Dissecting and Ligature Forceps  
23.5 cm



**Lower**

**PSI-5-664-18**

Dissecting and Ligature Forceps  
18.5 cm



**Lahey**

**PSI-5-665-19**

Bile Duct Clamp  
19.5 cm, 22.5 cm



**Finochietto**

**PSI-5-666-24**

Dissecting and Ligature Forceps  
24 cm



**Uro-Tangential**

**PSI-5-667-01**

Tangential Forceps  
25 cm, 27 cm

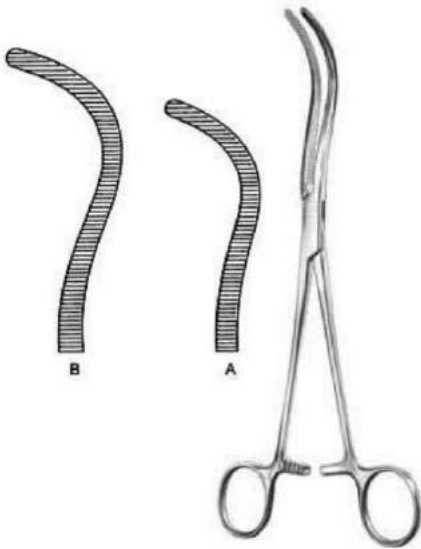

**Guyon**

**PSI-5-668-20**

Kidney Pedicle Clamp

23 cm , 24 cm



**Guyon**

**PSI-5-669-23**

Kidney Pedicle Clamp

19.5 cm , 21.5 cm, 24 cm



**Desjardins**

**PSI-5-670-21**

Bile Duct Clamp

21 cm



**Kelly**

**PSI-5-671-19**

Dissecting and Ligature Forceps

19.5 cm Fig. 1 , 22.5 cm Fig. 1 , 24.5 cm Fig. 1 , 19 cm Fig. 2 , 22 cm Fig. 2 , 24 cm Fig. 2 , 18.5 cm Fig. 3 , 23.5 cm Fig. 3, 21.5 cm Fig. 3



**Lawrence**

**PSI-5-672-28**

Dissecting and Ligature Forceps

28 cm



**Meeker**

**PSI-5-673-28**

Dissecting and Ligature Forceps

28 cm



**Negus**

**PSI-5-674-19**

Haemostatic Forceps

19.5 cm Fig. 1 , 20 cm Fig. 2



**Schaedel**

**PSI-5-701-09**

Towel Clamp sharp  
9 cm



**Jones**

**PSI-5-702-05**

Towel Clamp sharp  
5.5 cm, 8.5 cm



**Jones-Martin**

**PSI-5-703-09**

Towel Clamp sharp  
8.5 cm



**Backhaus**

**PSI-5-705-11**

Towel Clamp  
11.5 cm



**Backhaus**

**PSI-5-706-08**

Towel Clamp  
9 cm, 11.5 cm, 13 cm, 16 cm



**Peers-Bertram Modif.**

**PSI-5-707-15**

Towel Clamp wide jaw for tube fixation  
15.5 cm



**R?Der**  
**PSI-5-708-13**  
 Towel Clamp  
 13.5 cm

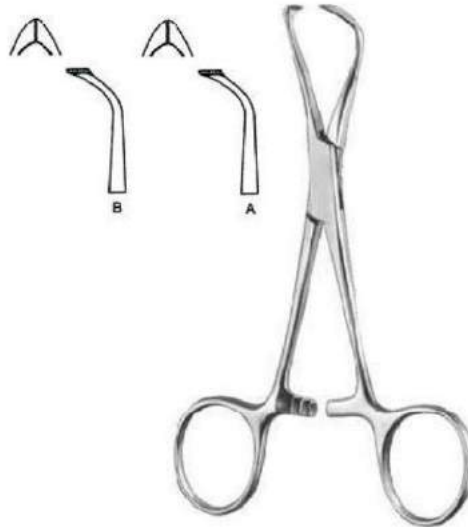

**Lorna**  
**PSI-5-709-10**  
 Towel Clamp fine serrated, wide jaw  
 9.5 cm, 13 cm



**Bernhard**  
**PSI-5-710-16**  
 Towel Clamp  
 16.5 cm

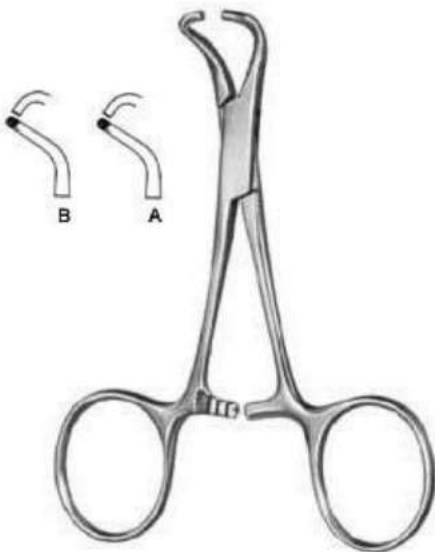

**Tohoku**  
**PSI-5-711-10**  
 Towel Clamp  
 10.5 cm blunt, 13.5 cm blunt, 14.5 cm

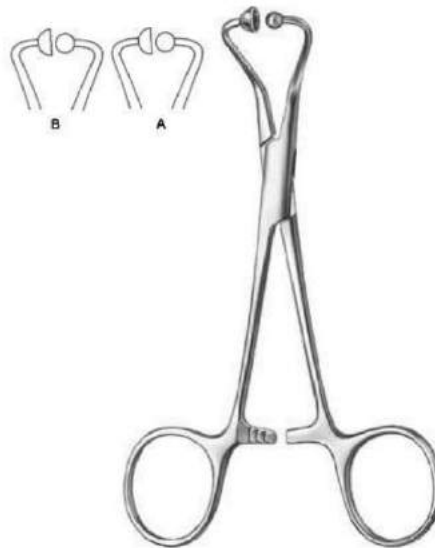

**Towel Clamp For Paper Clothes**  
**PSI-5-712-11**  
 Towel Clamp for paper clothes  
 11.5 cm, 14 cm



**Lane**  
**PSI-5-713-20**  
 Lane  
 19.5 cm



**Tube Holder For Fixation Of Six Tubes**

**PSI-5-714-06**

Tube Holder for fixation of six tubes



**Tubing Clamp Extra Long Ratchet**

**PSI-5-715-14**

Tubing Clamp extra long ratchet  
14 cm



**Tubing Clamp**

**PSI-5-716-16**

Tubing Clamp  
16.5 cm

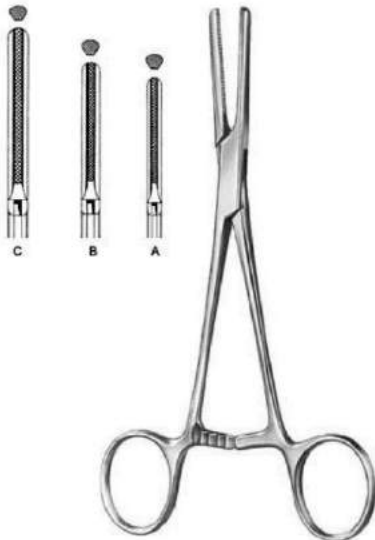

**Tubing Clamp**

**PSI-5-717-15**

Tubing Clamp  
15.5 cm, 19 cm, 20.5 cm

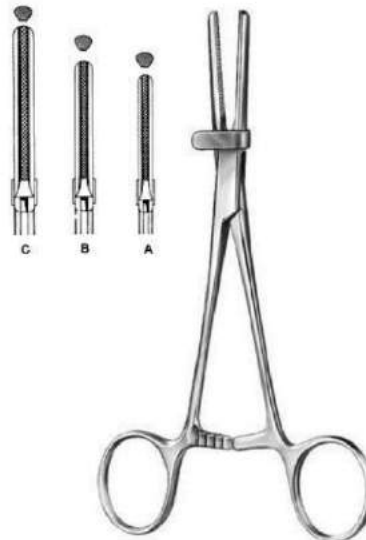

**Tubing Clamp With Safety Guard**

**PSI-5-718-15**

Tubing Clamp with safety guard  
15.5 cm, 19 cm, 20.5 cm

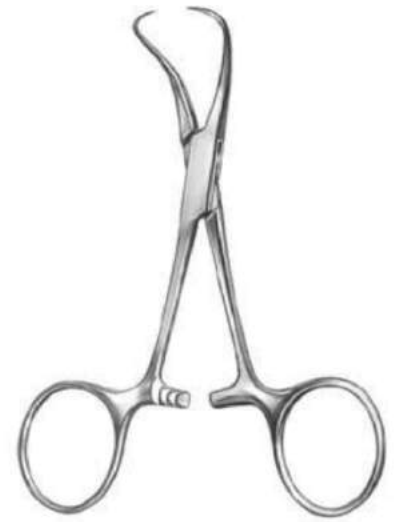

**Backhaus**

**PSI-5-704-11**

Towel Clamp  
11.5 cm, 13 cm

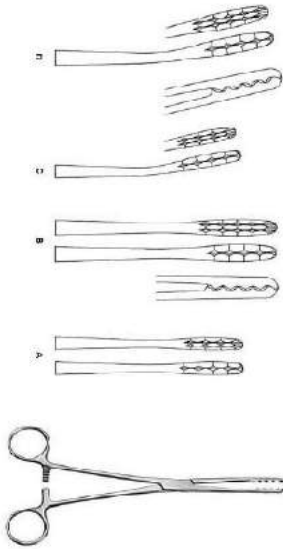

**Ulrich**

**PSI-5-801-22**

Dressing Forceps  
21.5 cm, 26.5 cm

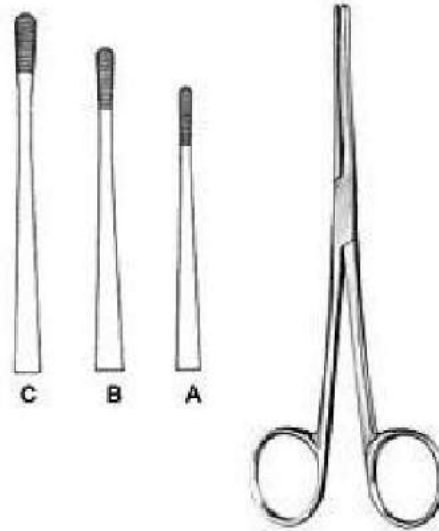

**Lister**

**PSI-5-802-13**

Sinus Forceps  
13 cm, 16 cm, 18 cm



**Martin**

**PSI-5-803-17**

Dressing Forceps  
17.5 cm, 17 cm

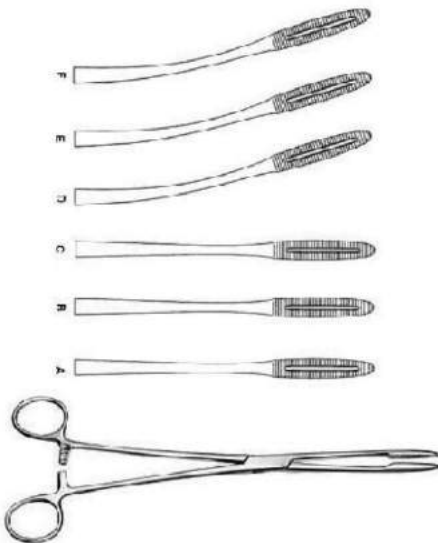

**Gross-Maier**

**PSI-5-804-20**

Dressing Forceps  
20.5 cm, 22 cm, 26.5 cm, 20 cm, 21.5 cm, 26 cm



**Tunneling Forceps**

**PSI-5-805-40**

Tunneling Forceps  
39.5 cm



**Collin**

**PSI-5-806-25**

Dressing Forceps  
25.5 cm



**Cheron**

**PSI-5-807-25**

Dressing Forceps

23.5 cm



**Bozemann**

**PSI-5-808-26**

Sponge Forceps

26 cm

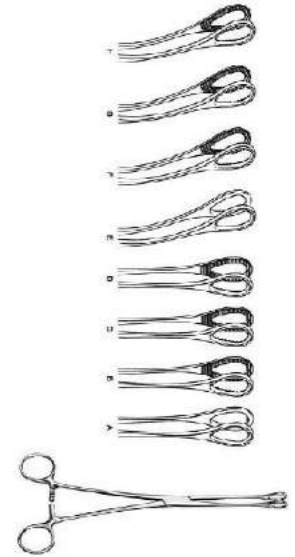

**Foerster**

**PSI-5-809-25**

Sponge Forceps

25 cm , 18 cm, 20.5 cm, 24.5 cm, 17.5 cm, 20 cm, 24.5 cm

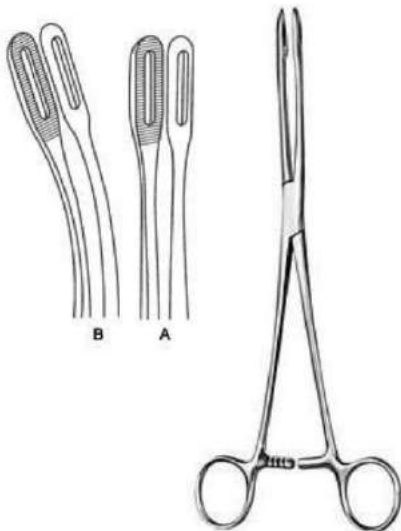

**Foerster**

**PSI-5-810-25**

Sponge Forceps

25 cm , 24.5 cm

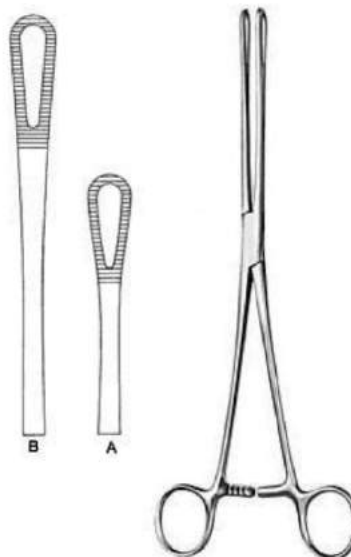

**Rampley**

**PSI-5-811-18**

Sponge Forceps

18.5 cm , 24.5 cm



**Vickers**  
**PSI-5-901-18**  
 Skin Hooklet  
 18.5 cm



**Vickers**  
**PSI-5-902-01**  
 Bone Hooklet  
 17 cm



**Vickers**  
**PSI-5-903-01**  
 Tendon Hooklet  
 17 cm



**Vickers**  
**PSI-5-904-02**  
 Hooklet  
 16 cm

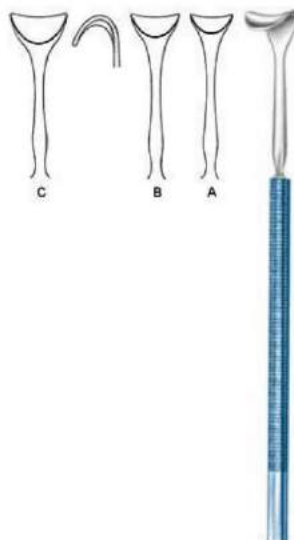

**Vickers**  
**PSI-5-905-12**  
 Saddle Hook  
 14 cm



**Graefe**  
**PSI-5-906-01**  
 Micro Hooklet  
 15 cm

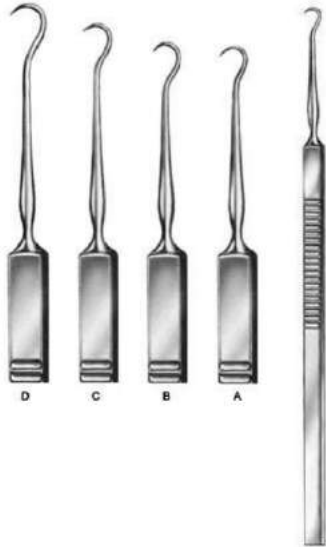

**Skin Hook**

**PSI-5-907-01**

Skin Hook

16 cm Fig. 1, 16 cm Fig. 2, 16 cm Fig. 3, 16 cm Fig. 4



**O Connor**

**PSI-5-908-16**

Skin Hook

16 cm

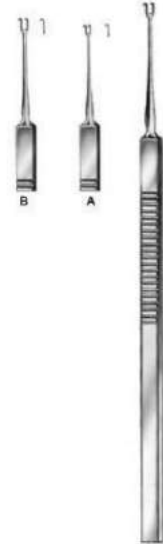

**Guthrie**

**PSI-5-909-01**

Skin Hook

15.5 cm



**Hooklet**

**PSI-5-910-01**

Hooklet

16.5 cm



**Hooklet**

**PSI-5-911-01**

Hooklet

16.5 cm



**Hooklet**

**PSI-5-912-02**

Hooklet

16 cm



**Hooklet**  
**PSI-5-913-04**  
 Hooklet  
 16.5 cm



**Vessel Hook**  
**PSI-5-914-12**  
 Vessel Hook  
 12 cm



**Desmarres**  
**PSI-5-915-08**  
 Saddle Hook  
 16 cm 8 mm, 16 cm 10 mm, 16 cm 12 mm, 16 cm 14 mm, 16 cm 16 mm, 16 cm 18 mm

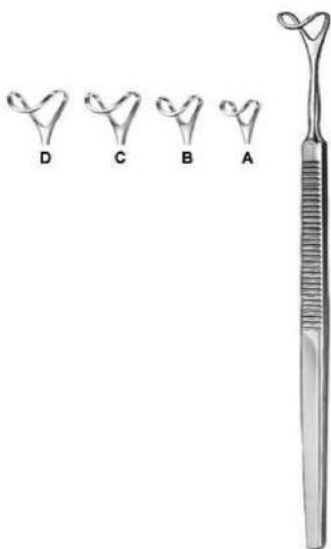

**Saddle Hook**  
**PSI-5-916-12**  
 Saddle Hook  
 16 cm 12 mm, 16 cm 14 mm, 16 cm 16 mm, 16 cm 18 mm



**Langenbeck-Mini**  
**PSI-5-917-10**  
 Langenbeck-Mini  
 16 cm



**Hooklet**  
**PSI-5-918-16**  
 Hooklet  
 16 cm 14 x 8



**Hooklet**  
**PSI-5-919-01**  
 Hooklet  
 16.5 cm



**Hooklet**  
**PSI-5-920-01**  
 Hooklet  
 16.5 cm



**Meyerding**  
**PSI-5-921-01**  
 Hooklet  
 17.5 cm Fig. 1, 17.5 cm Fig. 2, 17.5 cm Fig. 3, 17.5 cm Fig. 4, 17.5 cm Fig. 5, 17.5 cm Fig. 6



**Senn-Green**  
**PSI-5-922-01**  
 Hooklet  
 15 cm Fig. 1, 15 cm Fig. 2



**Ragnell-Davis**  
**PSI-5-923-14**  
 Hooklet  
 14 cm

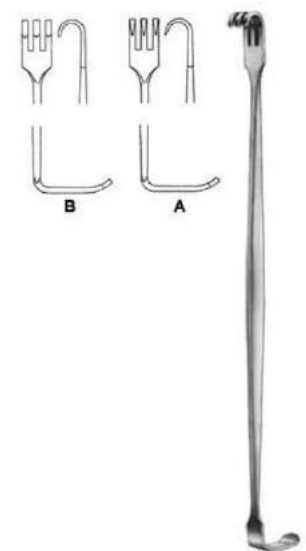

**Senn-Miller**  
**PSI-5-924-16**  
 Hooklet  
 16 cm



**Cushing**

**PSI-5-925-20**

Cushing  
20.5 cm

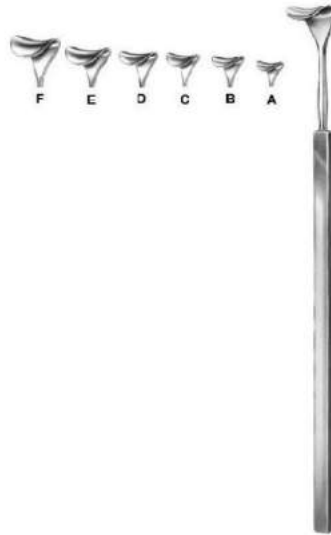

**Cushing**

**PSI-5-926-08**

Saddle Hook  
20.5 cm 8 mm wide , 20.5 cm 10 mm wide, 20.5 cm 12 mm wide, 20.5 cm 14 mm wide, 20.5 cm 16 mm wide, 20.5 cm 18 mm wide



**Cushing**

**PSI-5-927-08**

Saddle Hook 8 mm to 18 mm wide  
24 cm



**Brom**

**PSI-5-928-01**

Vein Hook  
19.5 cm



**Strandell-Stillie**

**PSI-5-929-01**

Strandell-Stillie  
19 cm Fig. 1, 19 cm Fig. 2



**Klapp**

**PSI-5-930-01**

Retractor 12 x 6, 12 x 11, 15 x 11  
17.5 cm



**Hooklet**  
PSI-5-931-04  
Hooklet  
16.5 cm

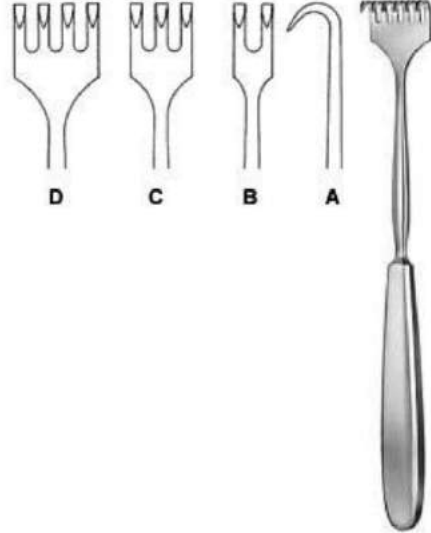

**Volkmann**  
PSI-5-932-01  
Retractor  
21.5 cm

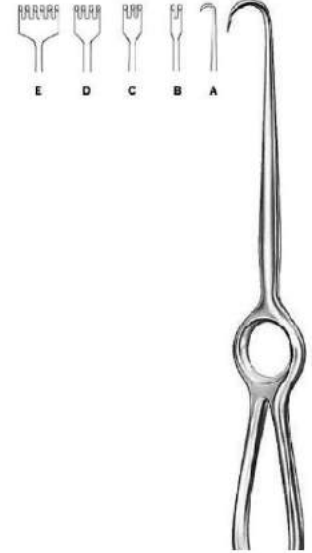

**Volkmann**  
PSI-5-933-01  
Retractor  
22 cm, 21.5 cm



**Kocher**  
PSI-5-934-01  
Retractor  
22 cm

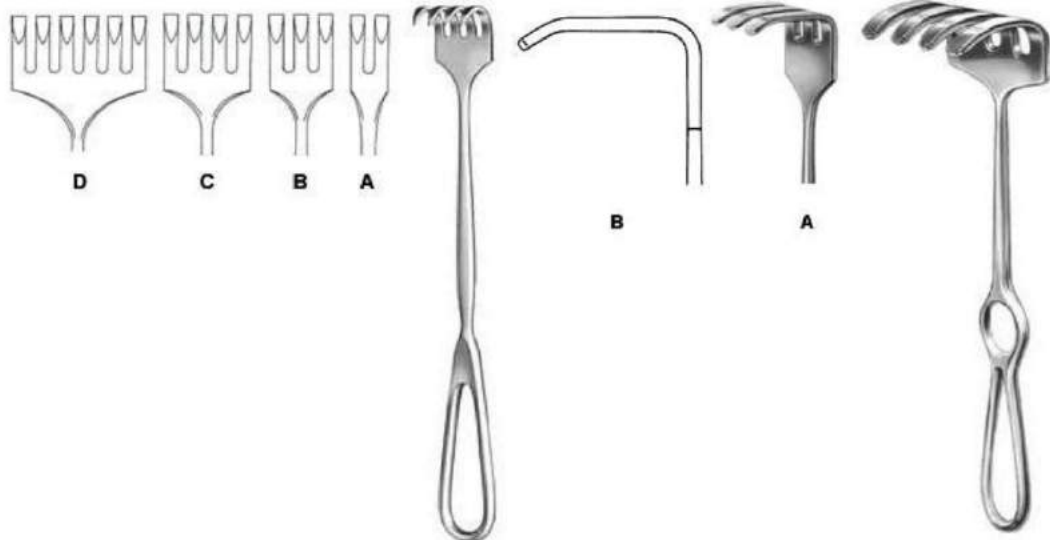

**Martin**  
PSI-5-935-02  
Retractor  
22.5 cm

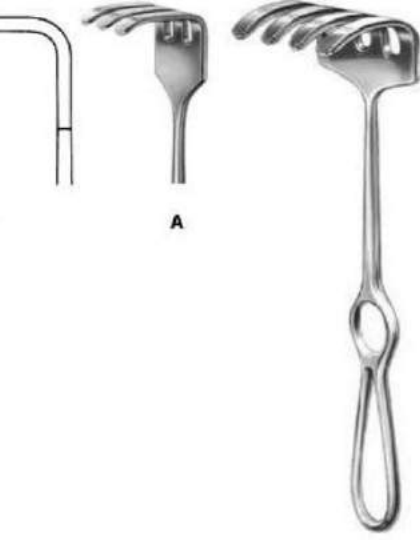

**Ollier**  
PSI-5-936-03  
Retractor  
23 cm 36 x 30, 23 cm 36 x 60



**Wassmund**

**PSI-5-937-02**

Retractor

20.5 cm 33 x 21

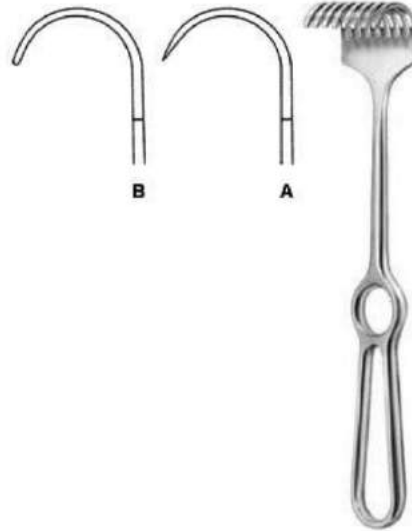

**Korte**

**PSI-5-938-08**

Retractor

24.5 cm 40 x 30

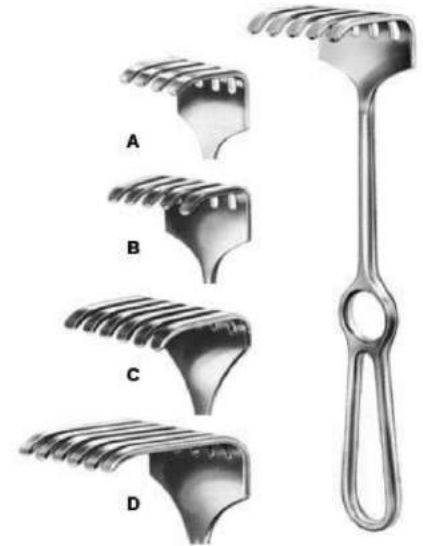

**Israel**

**PSI-5-939-04**

Retractor

25.5 cm

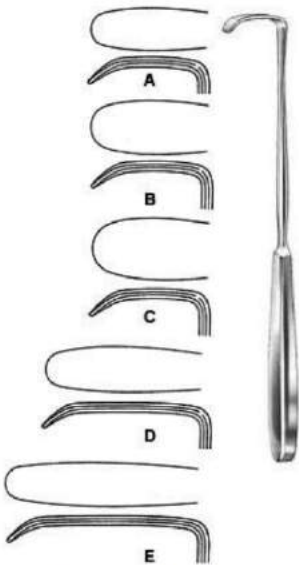

**Langenbeck**

**PSI-5-940-01**

Retractor

22.5 cm 30 x 11 mm, 22.5 cm 30 x 14 mm, 22.5 cm 30 x 16 mm, 22.5 cm 40 x 11 mm, 22.5 cm 50 x 11 mm



**Langenbeck**

**PSI-5-942-21**

Retractor

21 cm 65 x 20 mm

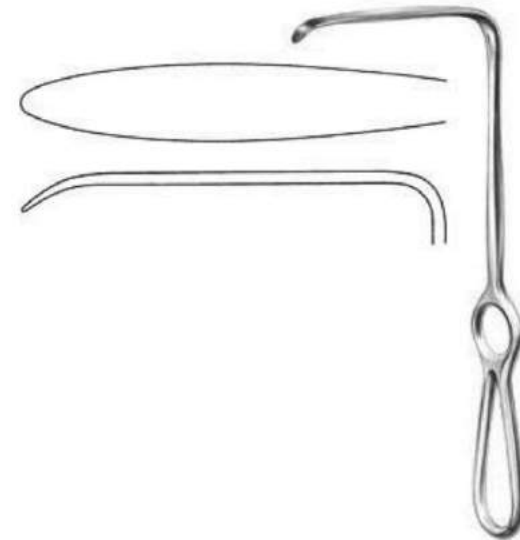

**Langenbeck**

**PSI-5-943-21**

Retractor

22.5 cm 85 x 15 mm

Retractors



**Lahey**

**PSI-5-944-19**

Retractor

19.5 cm 36 x 19 mm



**Little**

**PSI-5-945-20**

Retractor

20 cm 13 x 15 mm



**Kocher**

**PSI-5-946-18**

Retractor

23 cm 43 x 18 mm, 23 cm 53 x 20 mm, 23 cm 63 x 25 mm, 23 cm 77 x 30 mm, 23 cm 78 x 40 mm

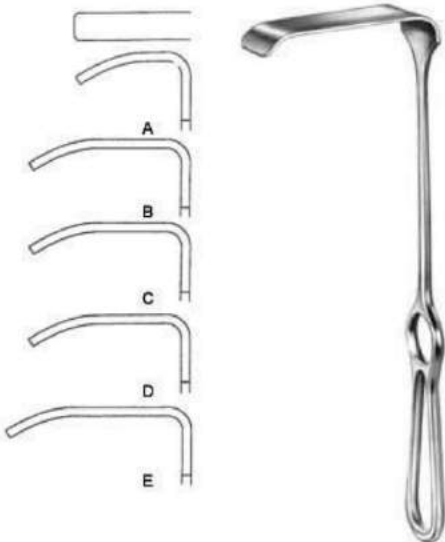

**Kocher-Langenbeck**

**PSI-5-947-01**

Retractor

21.5 cm 25 x 6 mm, 21.5 cm 35 x 8 mm, 21.5 cm 35 x 11 mm, 21.5 cm 35 x 15 mm, 21.5 cm 40 x 11 mm, 21.5 cm 55 x 11 mm, 21.5 cm 70 x 14 mm, 21.5 cm 80 x 12 mm



**Kocher-Langenbeck**

**PSI-5-948-01**

Retractor

21.5 cm 25 x 10 mm, 21.5 cm 40 x 13 mm, 21.5 cm 60 x 13 mm, 21.5 cm 40 x 18 mm, 21.5 cm 60 x 18 mm, 21.5 cm 85 x 18 mm, 21.5 cm 60 x 25 mm, 21.5 cm 85 x 25 mm

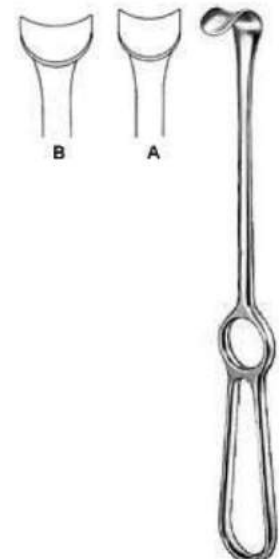

**Kocher**

**PSI-5-949-01**

Retractor

21.5 cm 22 x 12, 21.5 cm 24 x 14 mm

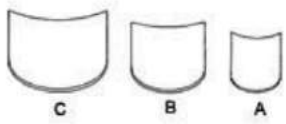

#### Kocher

PSI-5-950-01

Retractor

22 cm 42 x 10 mm, 22 cm 42 x 15 mm, 22 cm 43 x 20 mm

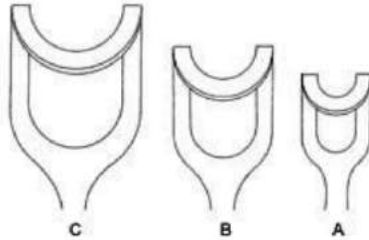

#### Middeldorpf

PSI-5-951-01

Retractor

21.5 cm 18 x 17 mm, 23 cm 25 x 22 mm, 24.5 cm 30 x 31 mm

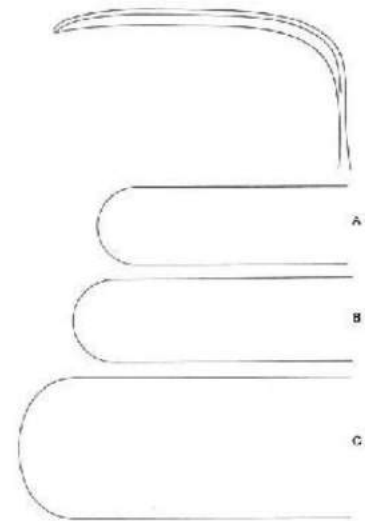

#### Doyen-Stillé

PSI-5-952-01

Retractor

26 cm 97 x 29 mm, 26 cm 101 x 31 mm, 26 cm 127 x 52 mm

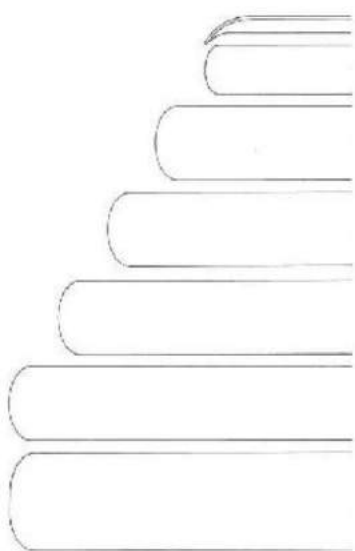

#### Hosel

PSI-5-953-01

Retractor

26 cm 63 x 21 mm, 26 cm 83 x 30 mm, 26 cm 103 x 30 mm, 26 cm 120 x 30 mm, 26 cm 140 x 30 mm, 26 cm 140 x 40 mm

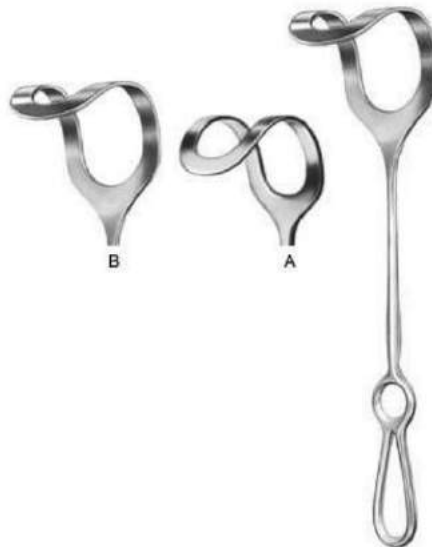

#### Middeldorpf

PSI-5-954-01

Retractor

27 cm 48 x 45 mm, 27 cm 52 x 50 mm, 27 cm 60 x 70 mm

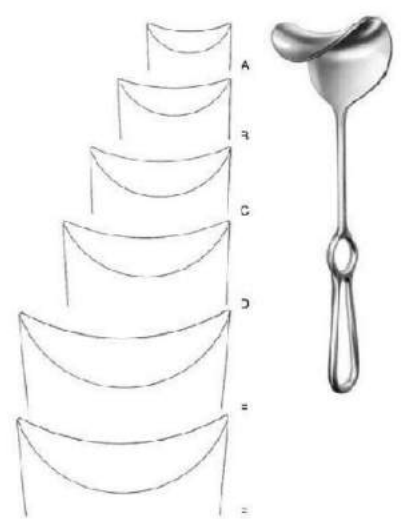

#### Fritsch

PSI-5-955-00

Retractor

23.5 cm 37 x 31 mm, 24 cm 38 x 40 mm, 25 cm 43 x 51 mm, 25 cm 49 x 61 mm, 25.5 cm 48 x 75 mm, 25.5 cm 65 x 85 mm



**Sauerbruch**

**PSI-5-962-25**

Retractor

25.5 cm 127 x 38 mm

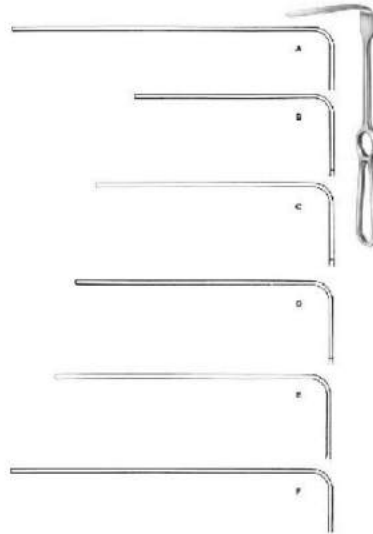

**Brunner**

**PSI-5-963-08**

Retractor

25.5 cm 84 x 20 mm, 25.5 cm 104 x 25 mm, 25.5 cm 124 x 30 mm, 25.5 cm 130 x 30 mm, 25.5 cm 144 x 30 mm, 25.5 cm 160 x 30 mm, 25.5 cm 164 x 30 mm

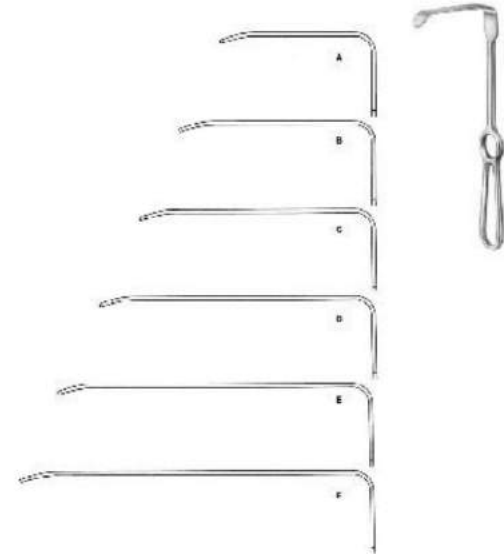

**Brunner**

**PSI-5-964-08**

Retractor

25.5 cm 82 x 20 mm, 25.5 cm 102 x 20 mm, 25.5 cm 122 x 25 mm, 25.5 cm 140 x 25 mm, 25.5 cm 162 x 30 mm, 25.5 cm 182 x 30 mm

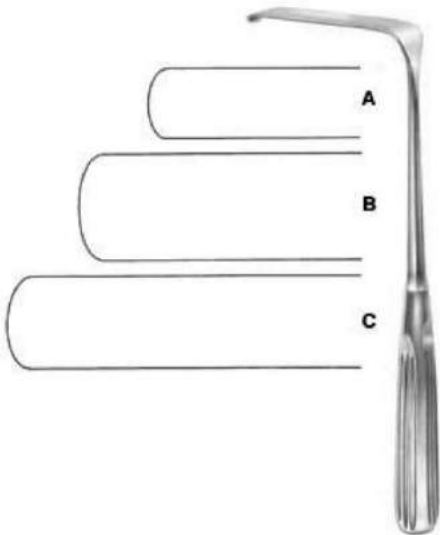

**Sauerbruch**

**PSI-5-965-01**

Retractor

22.5 cm 50 x 15 mm, 22.5 cm 63 x 23 mm, 22.5 cm 80 x 20 mm



**Deaver**

**PSI-5-966-01**

Retractor

18 cm 19 mm

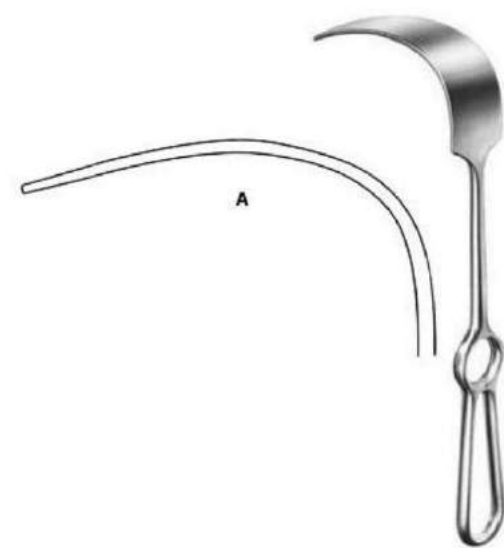

**Mikulicz**

**PSI-5-968-01**

Retractor

25 cm 90 x 35 mm, 25 cm 125 x 50 mm, 25 cm 160 x 50 mm



**Mikulicz**  
**PSI-5-969-26**  
 Retractor  
 26 cm 90 x 55 mm

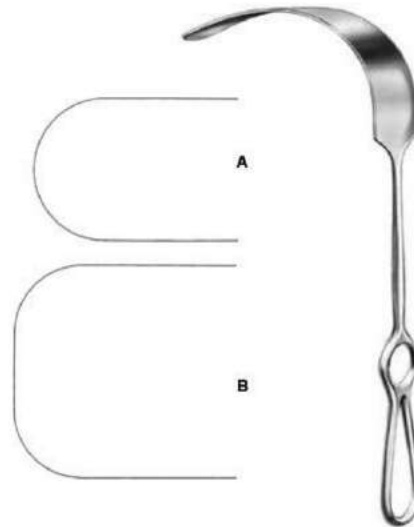

**Kelly**  
**PSI-5-970-01**  
 Retractor  
 27.5 cm 205 x 38 mm, 27.5 cm 205 x 57 mm



**Farabeuf**  
**PSI-5-971-00**  
 Retractor  
 15 cm Fig. 1 = 23 x 16, 15 cm Fig. 1 = 26 x 16, 15 cm Fig. 2 = 27 x 16, 15 cm Fig. 2 = 30 x 16

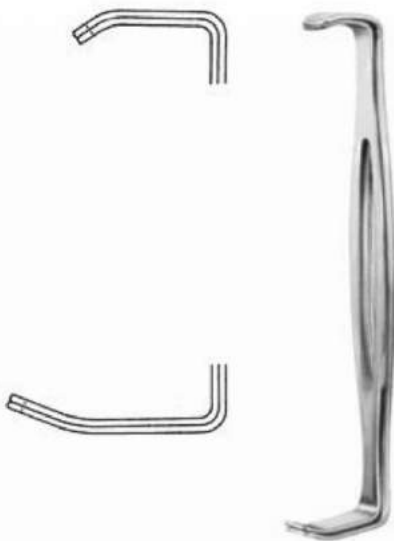

**Parker-Langenbeck**  
**PSI-5-972-00**  
 Retractor  
 21.5 cm Fig. 1 = 21x15 mm, 21.5 cm Fig. 1 = 40x15 mm, 21.5 cm Fig. 2 = 25x15 mm, 21.5 cm Fig. 2 = 45x15 mm



**Alm**  
**PSI-5-973-07**  
 Wound Spreaders, self-retaining  
 7 cm



**Alm**  
**PSI-5-974-07**  
 Wound Spreaders, self-retaining  
 7 cm



**Gosset**

**PSI-5-975-22**

Abdominal Retractor  
18.5 cm



**Balfour-Baby**

**PSI-5-976-00**

Abdominal Retractor spreading 90mm, 1 central  
blade 24 x 20 mm  
12.5 cm



**Balfour**

**PSI-5-977-00**

Abdominal retractor spreading 180 mm, lateral  
blades 70 x 35 mm, 1 central blade  
20 cm



**Deaver**

**PSI-5-967-04**

Retractor

31.5 cm 25 mm, 31.5 cm 38 mm, 31.5 cm 50 mm,  
31.5 cm 100 mm



**Probe**  
**PSI-5-1001-11**

Probe  
11.5cm, 13 cm , 14.5 cm , 16 cm, 18 cm, 20cm, 25 cm , 30 cm



**Probe**  
**PSI-5-1002-11**

Probe  
11.5 cm, 13 cm , 14.5 cm , 16 cm, 18 cm, 20cm, 25 cm , 30 cm



**Probe**  
**PSI-5-1003-13**

Probe  
13 cm , 14.5 cm , 16 cm, 18 cm, 20 cm, 25 cm



**Probe With Eye**  
**PSI-5-1004-13**

Probe with eye  
13 cm , 14.5 cm , 16 cm



**Myrtle Leaf Probe**  
**PSI-5-1006-13**

Myrtle Leaf Probe  
13 cm , 14.5 cm , 16 cm, 18 cm, 20 cm



**Grooved Director**  
**PSI-5-1007-13**

Grooved Director  
13 cm , 14 cm, 16 cm



**Grooved Director**

**PSI-5-1008-13**

Grooved Director  
13 cm , 14.5 cm , 16 cm



**Doyen**

**PSI-5-1009-14**

Grooved Director  
14.5 cm



**Nelaton**

**PSI-5-1010-16**

Grooved Director  
16 cm

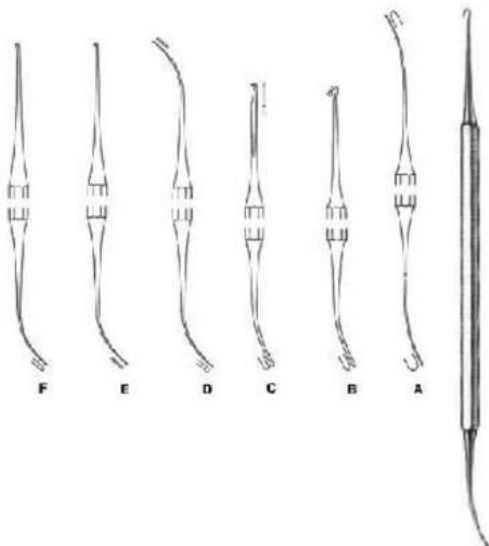

**Varady**

**PSI-5-1011-01**

Phlebotomiser  
18 cm, 17.5 cm

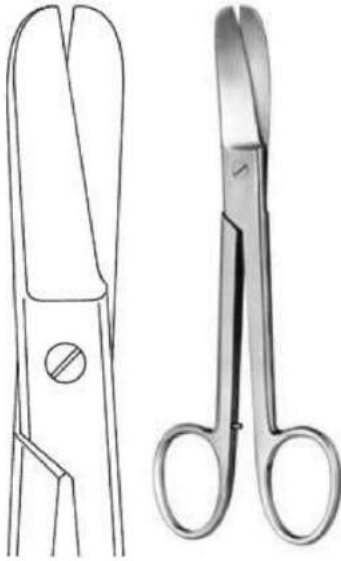

**Lorenz**

**PSI-6-101-23**

Bandage Scissors heavy pattern

23 cm



**Lister**

**PSI-6-102-14**

Bandage Scissors

14.5 cm , 18.5 cm , 20 cm

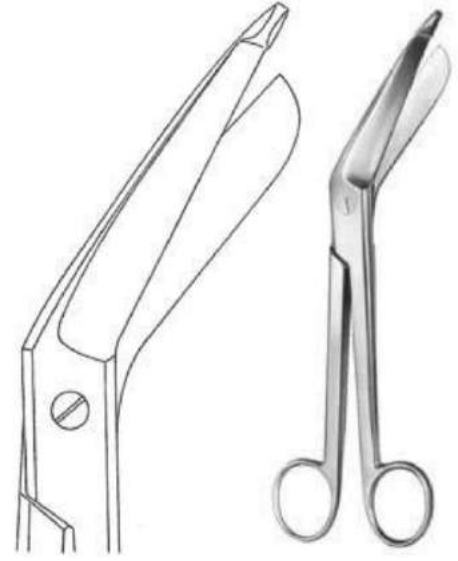

**Bergmann**

**PSI-6-103-23**

Plaster Shears

23.5 cm



**Esmarch**

**PSI-6-104-20**

Plaster Shears heavy pattern, short blades

20 cm



**Bandage Scissors Black Plastic Ring With Autodavable**

**PSI-6-105-15**

Bandage Scissors black plastic ring with

autodavable

16 cm, 19 cm



**Bandage Scissors Black Plastic Rings**

**PSI-6-106-18**

Bandage Scissors black plastic rings

16 cm, 19 cm

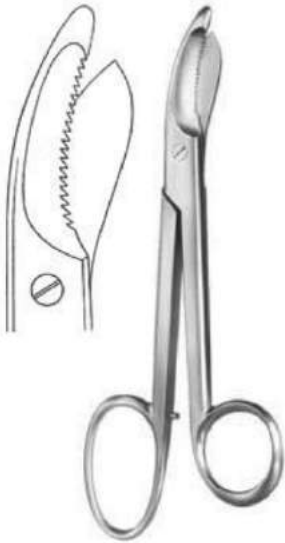

**Bruns**

**PSI-6-107-24**

Plaster Scissors

24 cm



**Stille-Martin**

**PSI-6-108-23**

Plaster Shears

23 cm , 27 cm, 38 cm

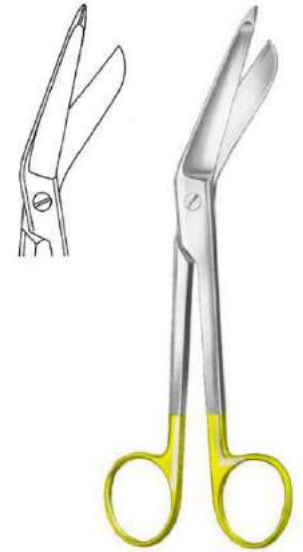

**Lister**

**PSI-6-109-18**

Bandage Scissors

18 cm

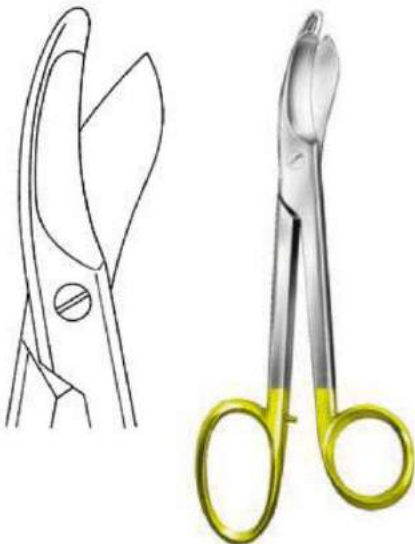

**Bruns**

**PSI-6-110-24**

Plaster Scissors

24 cm



**Hopkins**

**PSI-6-111-20**

Plaster Knife with wooden handle

20 cm



**Reiner**

**PSI-6-112-18**

Plaster Knife

18 cm



**Reiner**

**PSI-6-113-18**

Plaster Knife

18 cm



**Martin**

**PSI-6-114-21**

Plaster Knife with wooden handle

21 cm



**Engel**

**PSI-6-115-14**

Plaster Saw

15.5 cm

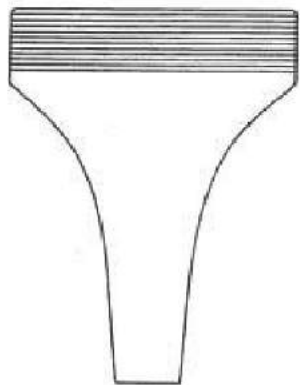

**Hennig**

**PSI-6-116-28**

Plaster Spreader

28 cm

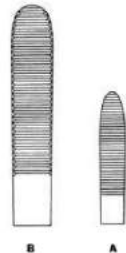

**Wolff**

**PSI-6-117-18**

Plaster Breaker

18 cm, 26.5 cm





**McKenzie**

**PSI-8-107-19**

Clip Applying Forceps

18.5 cm



**Olivecrona**

**PSI-8-108-18**

Dura Dissector

18 cm



**Olivecrona**

**PSI-8-109-19**

Dura Dissector

20 cm



**Milligan**

**PSI-8-110-21**

Dura Dissector

21.5 cm



**Davis**

**PSI-8-111-21**

Dura Dissector sharp

21.5 cm



**Dura Dissector**

**PSI-8-112-22**

Dura Dissector

22 cm



**Davis**

**PSI-8-113**

Dura Dissector  
24.5 cm



**Love**

**PSI-8-114-19**

Nerve Root Retractor  
21.5 cm, 18 cm, 11 cm



**Olivecrona**

**PSI-8-115-18**

Brain Spatula  
18 cm



**Scoville**

**PSI-8-116-23**

Nerve Root Retractor 8mm  
23.5 cm



**Holsher**

**PSI-8-117-24**

Nerve Root Retractor 8mm  
23.5 cm

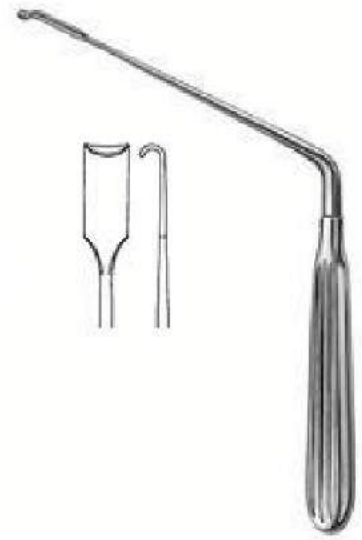

**Scoville**

**PSI-8-118-19**

Nerve Root Retractor 7mm  
16.5 cm



**Groningen**

**PSI-8-119-26**

Nerve Hook  
26.5 cm



**Groningen**

**PSI-8-120-26**

Nerve Hook  
26.5 cm



**Cushing**

**PSI-8-121-19**

Nerve Hook blunt  
19 cm , 28 cm



**Cushing**

**PSI-8-122-19**

Nerve Hook  
19.5 cm , 28 cm



**Smithwick**

**PSI-8-123-17**

Smithwick  
17 cm , 21 cm



**Halle**

**PSI-8-125-20**

Dura Knife  
20 cm



**Cloward**

**PSI-8-132-16**

Lamina Spreader  
16 cm

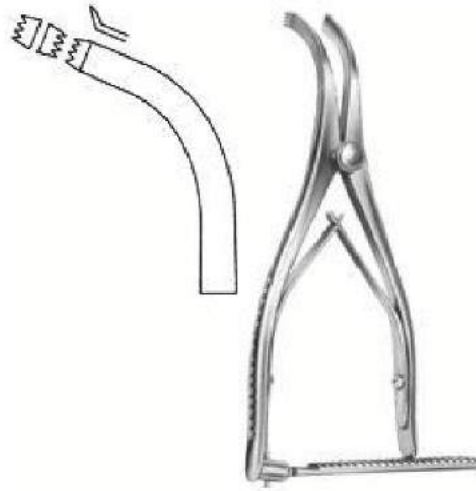

**Inge**

**PSI-8-133-17**

Lamina Spreader  
16 cm

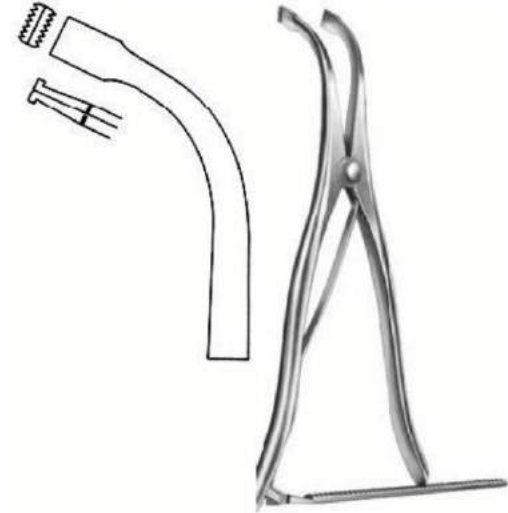

**Inge**

**PSI-8-134-27**

Lamina Spreader  
25.5 cm

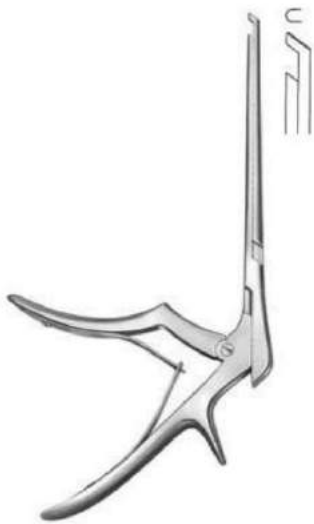

**Ferris-Smith Kerrison**

**PSI-8-135-03**

Laminectomy Punch 3mm downwards cutting 40 degree shaft length 180 mm

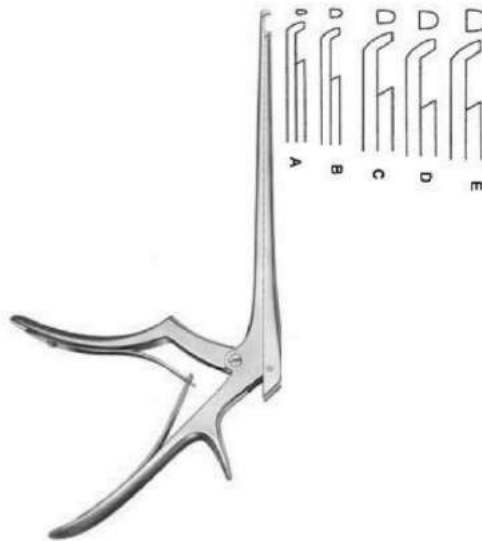

**Ferris-Smith Kerrison**

**PSI-8-138-01**

Laminectomy Punch upwards cutting shaft length 180 mm  
1 mm, 2 mm, 3 mm, 4 mm, 5 mm, 6 mm

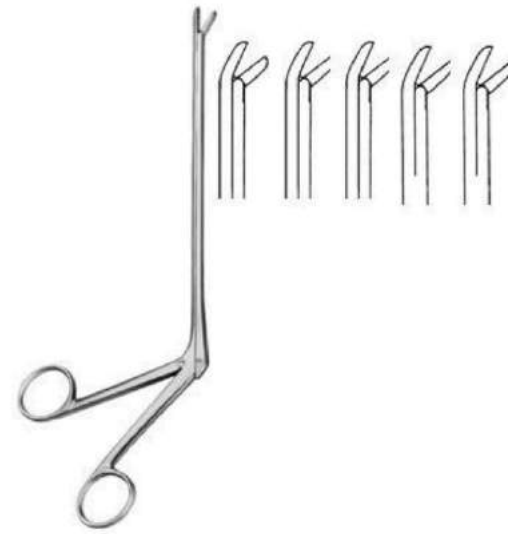

**Cushing**

**PSI-8-139-01**

Laminectomy Rongeur jaw 2 x 10 to 4 x 10 mm  
straight shaft length 180 mm



**DeBakey**

**PSI-9-216-05**

Vascular Dilator  
19 cm

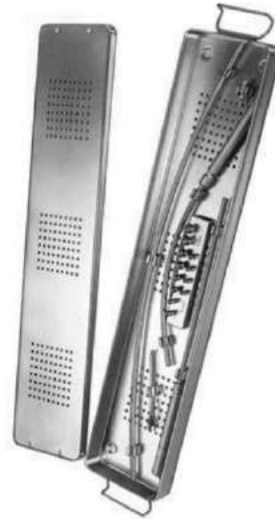

**Martin**

**PSI-9-217-00**

Tunneling Set complete set with three shafts, two handles and 12 tips in storage case.



**Hach**

**PSI-9-218-01**

Fasciotomy Knife with plastic handle  
30 cm



**Intima Spatula**

**PSI-9-219-18**

Intima Spatula  
18.5 cm

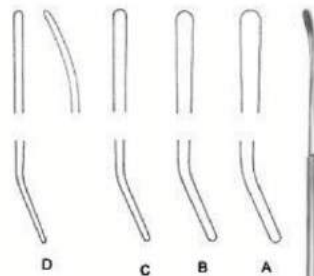

**Robb**

**PSI-9-220-01**

Vascular Dissector  
24 cm Fig. 1 2,5 mm ? , 24 cm Fig. 2 2,0 mm ?



**Crile**

**PSI-9-221-20**

Nerve Hooklet  
20 cm



**Bone Shear**

PSI-9-101-23

Bone Shear  
23 cm



**Rib Shear**

PSI-9-102-22

Rib Shear  
23 cm



**Gluck**

PSI-9-103-22

Rib Shears  
21 cm



**Giertz-Stille**

PSI-9-104-27

Rib Shear  
24.5 cm



**Lebsche**

PSI-9-105-24

Sternum Chisel  
24.5 cm



**Rib Retractor**

PSI-9-106-01

Rib Retractor lateral blades 12 x 16 mm spreading 95  
mm

Size 1



**Haight**

**PSI-9-113-90**

Rib Retractor lateral blades 30 x 30 mm spreading  
120 mm  
Size 1



**Morse-Favaloro**

**PSI-9-114-01**

Sternal Retractor 4 movable blades 17 x 22 mm  
spreading 160 mm Sternal Retractor  
Size 1



**Morse**

**PSI-9-115-00**

Sternal Retractor 4 movable blades 22 x 27 mm  
spreading 200 mm  
Size 1



**Tuffier**

**PSI-9-116-02**

Rib Retractor lateral blades 22 x 27 mm spreading  
200 mm  
Size 1

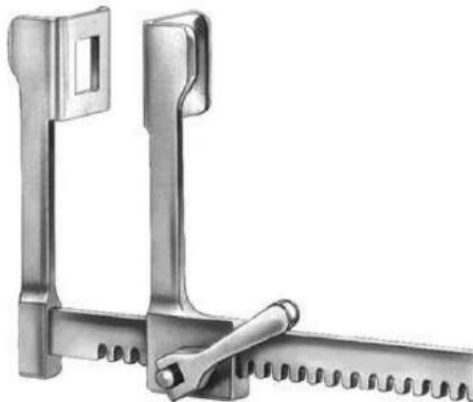

**Finochietto, Baby**

**PSI-9-117-75**

Rib Retractor lateral blades 14 x 15 mm spreading  
75 mm  
Size 1



**Finochietto**

**PSI-9-118-01**

Rib Retractor lateral blades 30 x 45 mm spreading  
150 mm  
Size 1



**Finochietto, Infant**

**PSI-9-107-01**

Rib Retractor lateral blades 15 x 15 mm spreading

75 mm

Size 1



**Finochietto, Baby**

**PSI-9-108-01**

Rib Retractor lateral blades 31 x 31 mm spreading

100 mm

Size 1



**Finochietto**

**PSI-9-109-01**

Rib Retractor lateral blades 40 x 45 mm spreading

135 mm

Size 1



**Burford**

**PSI-9-110-01**

Rib Retractor with two pairs of blades 47 x 62 mm + 65 x 62 mm, spreading 200 mm

Size 1



**Castaneda**

**PSI-9-111-01**

Rib Retractor lateral blades 10,5 x 32 mm spreading

65 mm

Size 1



**Finochietto (Modif.)**

**PSI-9-112-01**

Rib Retractor lateral blades 14 x 15 mm spreading

120 mm

Size 1



**DeBakey**

**PSI-9-119-00**

Rib Retractor spreading 150 mm  
Size 1



**DeBakey**

**PSI-9-120-00**

Rib Retractor spreading 200 mm  
Size 1



**Thoracic Retractor**

**PSI-9-121-00**

Thoracic Retractor  
Size 1



**Sellors**

**PSI-9-121-00**

Rib Contractor  
20 cm



**Bailey-Baby**

**PSI-9-123-14**

Rib Contractor  
15.5 cm



**Bailey**

**PSI-9-124-16**

Rib Contractor  
20 cm



**Bailey-Gibbon**

PSI-9-125-16

Rib Contractor  
20 cm



**Allison**

PSI-9-126-30

Lung Spatula  
29.5 cm, 32.5 cm

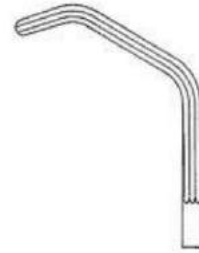

**Price-Thomas**

PSI-9-127-22

Bronchus Clamp  
22 cm



**Price-Thomas**

PSI-9-128-22

Bronchus Clamp  
22 cm

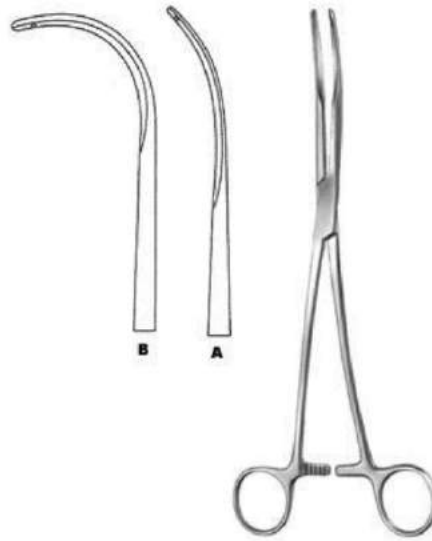

**Semb**

PSI-9-129-24

Bronchus Clamp  
24.5 cm

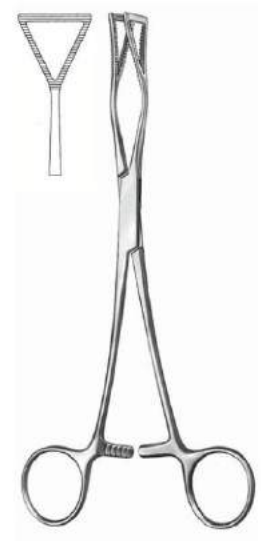

**Lovlace**

PSI-9-130-20

Lung Grasping Forceps  
20.5 cm

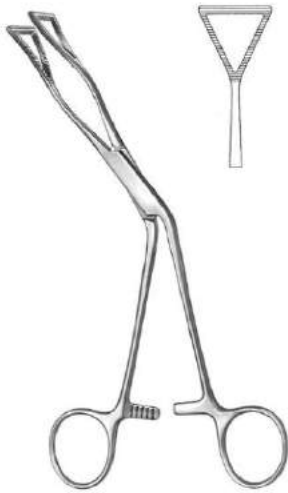

**Lovelace**

**PSI-9-131-20**

Lung Grasping Forceps  
19 cm



**DeBakey-Satinsky**

**PSI-9-132-07**

Bulldog Clamp  
7", 9 cm



**Glover**

**PSI-9-133-06**

Bulldog Clamp  
6 cm



**Santulli**

**PSI-9-134-07**

Bulldog Clamp  
7



**Gregory, Soft**

**PSI-9-135-09**

Bulldog Clamp  
9 cm, 11 cm



**Gregory**

**PSI-9-136-01**

Bulldog Clamp  
10.5 cm

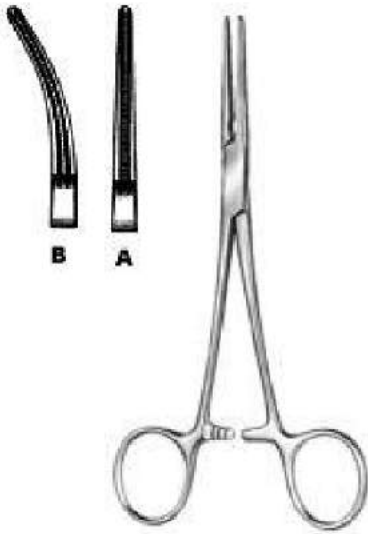

**DeBakey-Rankin**

**PSI-9-137-16**

Haemostatic Forceps  
16 cm



**DeBakey-Mosquito**

**PSI-9-138-15**

Haemostatic Forceps  
15 cm



**Ochsner**

**PSI-9-139-23**

Aortic Clamp  
23.5 cm



**Diethrich**

**PSI-9-140-21**

Aortic Clamp  
22 cm



**Dardik**

**PSI-9-141-00**

Multi purpose Vascular Clamp  
15 cm



**Dale**

**PSI-9-142-18**

Peripheral Vascular Clamp  
18 cm

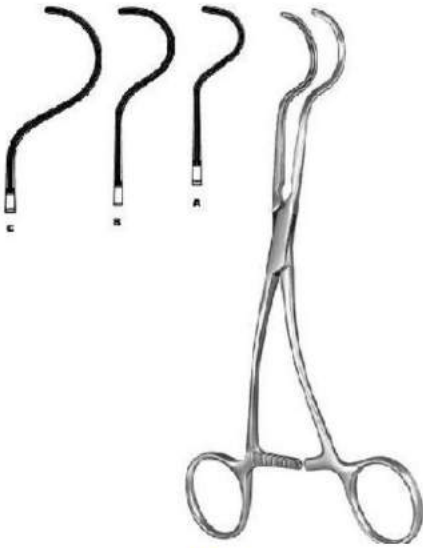

**Dale**

PSI-9-143-17

Peripheral Vascular Clamp  
17.5 cm

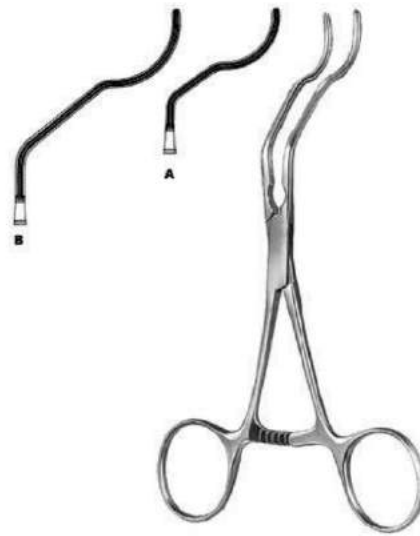

**Gregory**

PSI-9-144-14

Profunda Clamp  
13 cm, 16 cm, 18 cm

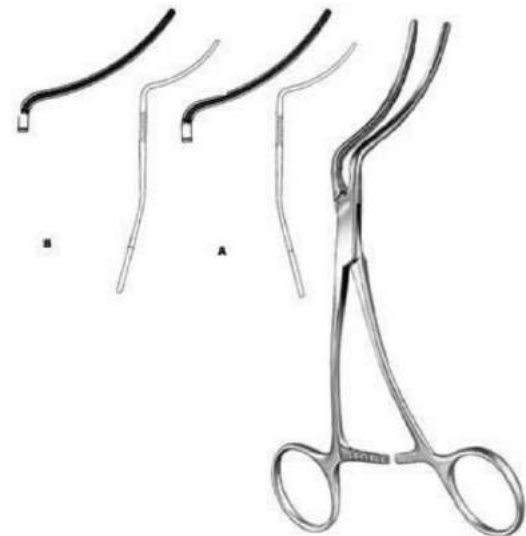

**Martin**

PSI-9-145-16

Peripheral Vascular Clamp  
16.5 cm



**Husfeldt**

PSI-9-146-18

Peripheral Vascular Clamp  
17.5 cm



**Husfeldt**

PSI-9-147-18

Peripheral Vascular Clamp  
18 cm

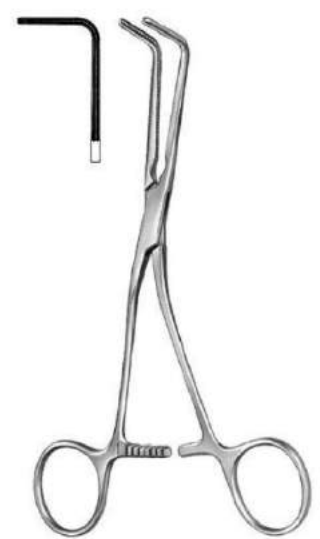

**Husfeldt**

PSI-9-148-17

Peripheral Vascular Clamp  
17 cm



**DeBakey**

**PSI-9-149-16**

Vascular Forceps  
16 cm



**DeBakey**

**PSI-9-150-16**

Vascular Forceps  
16 cm



**DeBakey**

**PSI-9-151-16**

Vascular Forceps  
16 cm

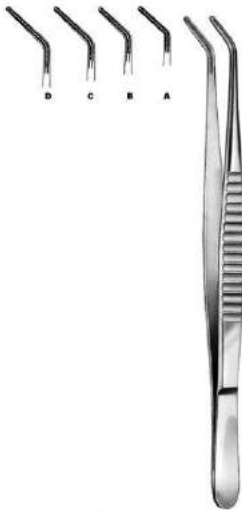

**DeBakey**

**PSI-9-152-16**

Vascular Forceps  
16 cm



**DeBakey**

**PSI-9-153-16**

Vascular Forceps  
16 cm



**DeBakey**

**PSI-9-154-07**

Bulldog Clamp  
7



**DeBakey**

**PSI-9-155-07**

Bulldog Clamp

7



**Applying Forceps**

**PSI-9-156-23**

Applying Forceps

23.5 cm



**Glover**

**PSI-9-157-06**

Bulldog Clamp

7



**Glover**

**PSI-9-158-06**

Bulldog Clamp

6.5 cm

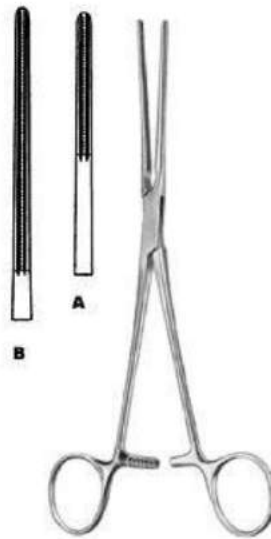

**Potts**

**PSI-9-159-21**

Coarctation Clamp

21 cm

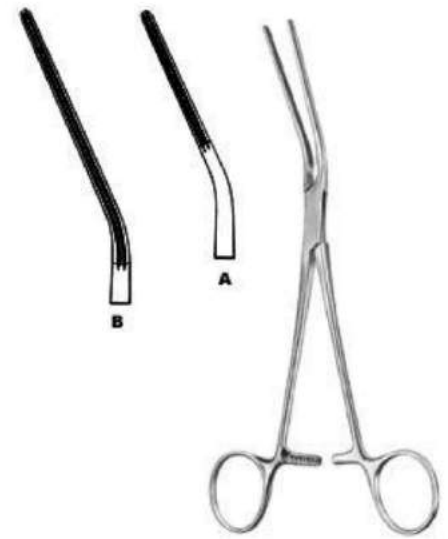

**Potts**

**PSI-9-160-21**

Coarctation Clamp

20.5 cm

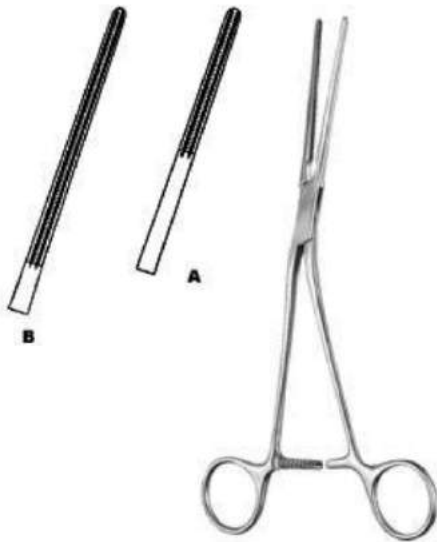

**Potts**

**PSI-9-161-21**  
Coarctation Clamp  
20.5 cm



**Potts**

**PSI-9-162-22**  
Anastomosis Clamp  
21.5 cm



**Potts**

**PSI-9-163-22**  
Anastomosis Clamp  
22 cm

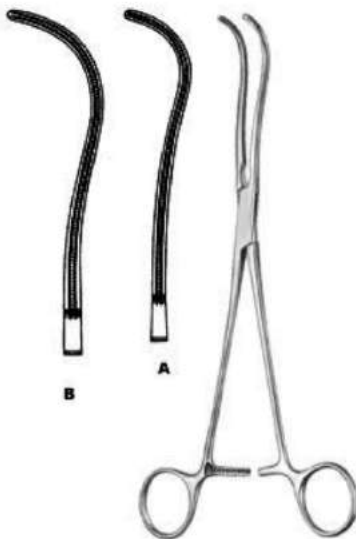

**DeBakey**

**PSI-9-164-19**  
Ligature Forceps  
19 cm



**DeBakey**

**PSI-9-165-16**  
Peripheral Vascular Clamp  
16 cm



**DeBakey**

**PSI-9-166-19**  
Peripheral Vascular Clamp  
16 cm

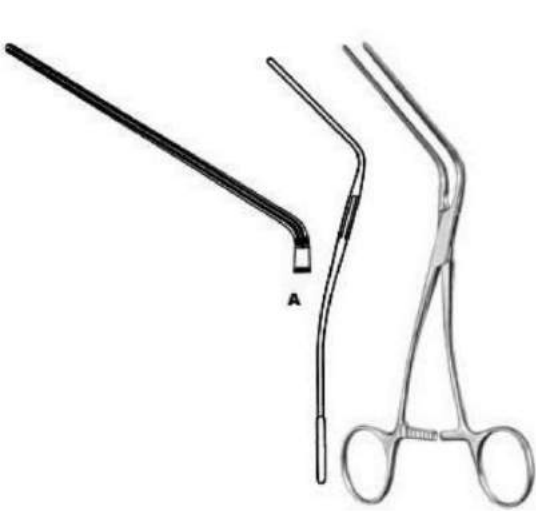

**Leland-Jones**

**PSI-9-167-18**

Peripheral Vascular Clamp  
18 cm

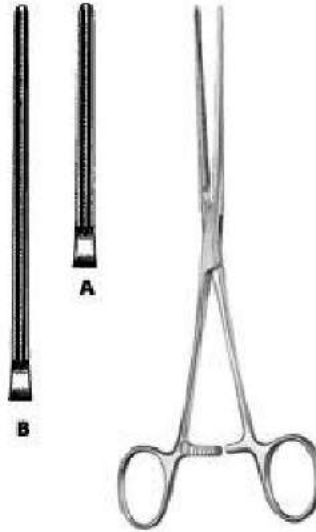

**Bainbridge**

**PSI-9-168-15**

Multi purpose Vascular Clamp  
15 cm



**Bainbridge**

**PSI-9-169-15**

Multi purpose Vascular Clamp  
15 cm

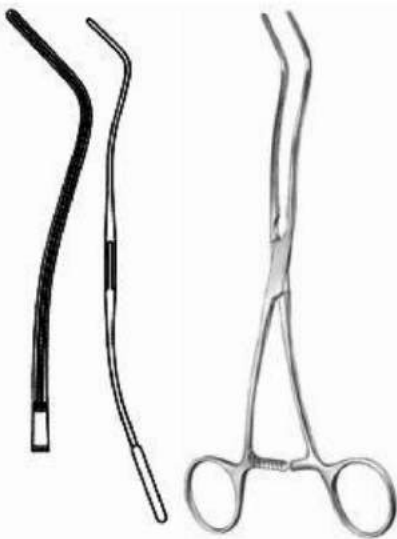

**DeBakey**

**PSI-9-170-20**

Multi purpose Vascular Clamp  
20 cm



**DeBakey**

**PSI-9-171-26**

Aortic Aneurysm Clamp  
26 cm



**DeBakey**

**PSI-9-172-28**

Aortic Aneurysm Clamp  
28 cm

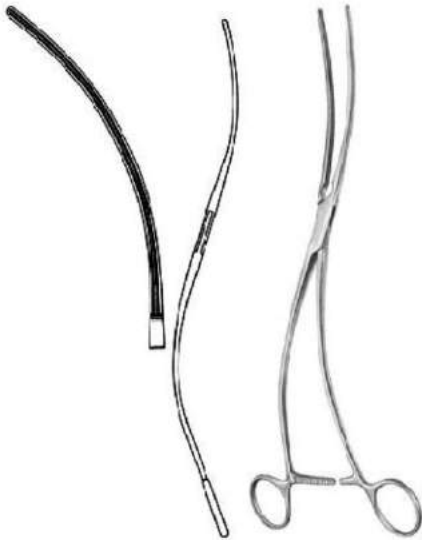

**DeBakey**

PSI-9-173-30

Aortic Aneurysm Clamp  
30 cm



**DeBakey**

PSI-9-174-27

Aortic Clamp  
27 cm



**DeBakey**

PSI-9-175-24

Ligature Forceps  
24.5 cm



**DeBakey**

PSI-9-176-24

Ligature Forceps  
24.5 cm



**DeBakey**

PSI-9-178-25

Ligature Forceps  
27 cm

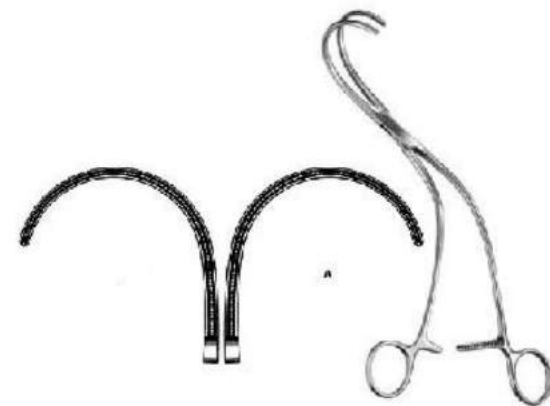

**Weber**

PSI-9-179-01

Aortic Clamp  
24 cm



**Satinsky**

PSI-9-180-20

Tangential Occlusion Clamp

22 cm



**Harken**

PSI-9-181-01

Auricle Clamp

24.5 cm



**Lees**

PSI-9-182-23

Bronchus Clamp

23 cm



**Lees**

PSI-9-183-25

Bronchus Clamp

25 cm



**Lambert-Kay**

PSI-9-184-21

Anastomosis Clamp

22.5 cm



**DeBakey**

PSI-9-185-17

Anastomosis Clamp

16.5 cm



**Morris-DeBakey**

**PSI-9-186-18**

Aortic Clamp  
16.5 cm



**DeBakey-Bahnson**

**PSI-9-187-23**

Aneurysm Clamp  
23.5 cm

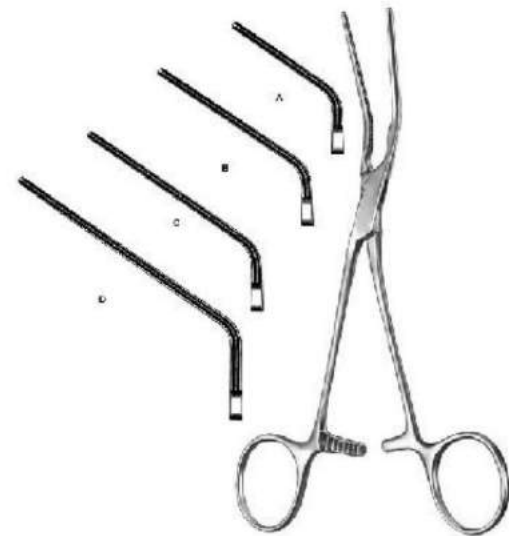

**DeBakey**

**PSI-9-188-20**

Multi purpose Vascular Clamp  
18 cm

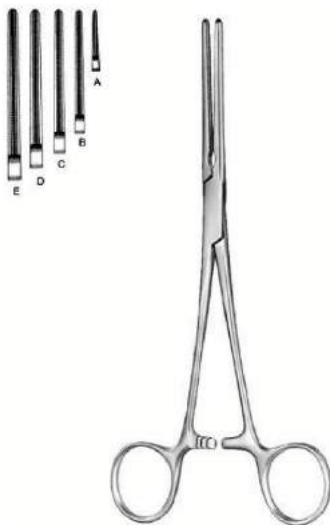

**DeBakey-Mosquito**

**PSI-9-189-12**

Haemostatic Forceps  
12.5 cm



**DeBakey-Mosquito**

**PSI-9-190-12**

Haemostatic Forceps  
12.5 cm



**DeBakey**

**PSI-9-191-17**

Multi purpose Vascular Clamp  
17 cm



**DeBakey**

**PSI-9-192-16**

Multi purpose Vascular Clamp  
16.5 cm

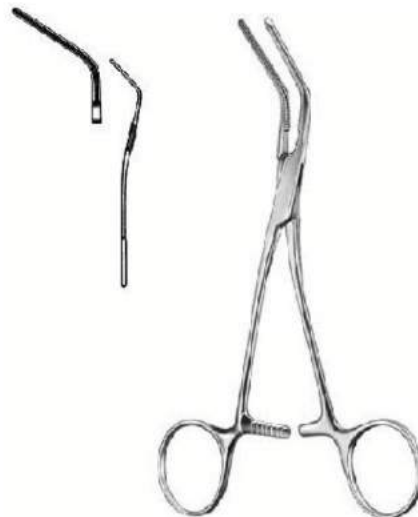

**DeBakey**

**PSI-9-193-15**

Multi purpose Vascular Clamp  
16 cm



**DeBakey**

**PSI-9-194-15**

Multi purpose Vascular Clamp  
16.5 cm



**DeBakey**

**PSI-9-195-17**

Multi purpose Vascular Clamp  
16.5 cm



**Glover**

**PSI-9-196-17**

Multi purpose Vascular Clamp  
17 cm



**Glover**

**PSI-9-197-17**

Multi purpose Vascular Clamp  
17.5 cm

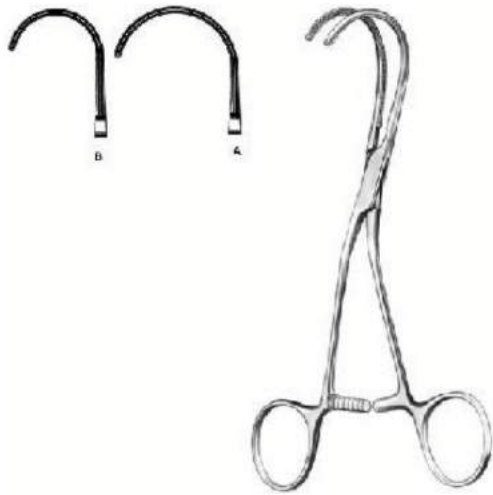

**DeBakey**

**PSI-9-198-16**

Multi purpose Vascular Clamp  
16.5 cm

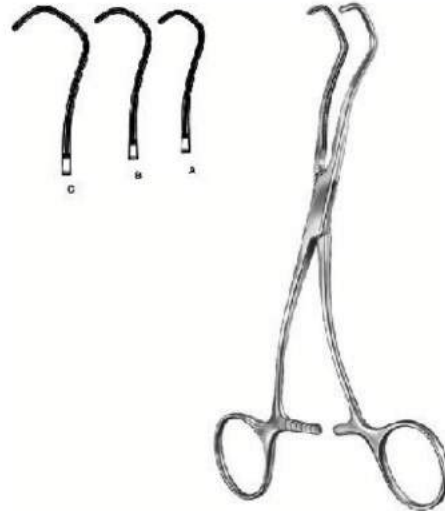

**Derra**

**PSI-9-199-16**

Anastomosis Clamp  
16 cm Fig. 1, 17.5 cm Fig. 3, 18.5 cm Fig. 3



**DeBakey-Beck**

**PSI-9-200-17**

Anastomosis Clamp  
17 cm



**Cooley**

**PSI-9-201-16**

Vascular Forceps  
16 cm

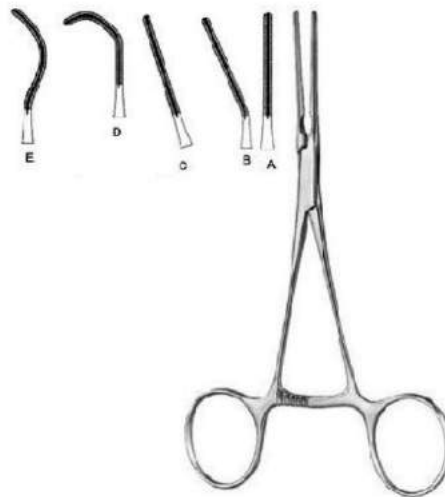

**Cooley**

**PSI-9-202-01**

Pediatric Vascular Clamp  
14.5 cm

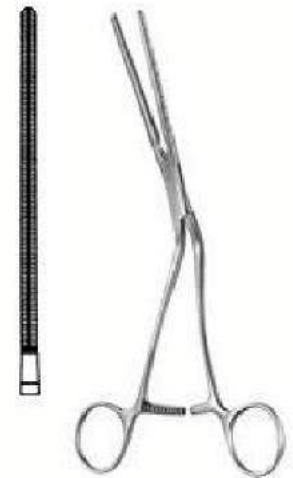

**Cooley**

**PSI-9-203-21**

Iliac Clamp  
22 cm



**Cooley**

PSI-9-204-17

Anastomosis Clamp  
17 cm

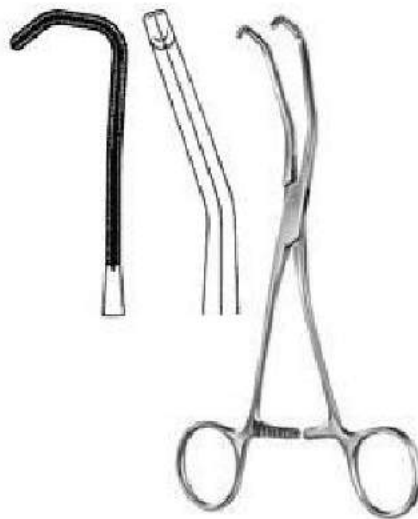

**Cooley**

PSI-9-205-17

Anastomosis Clamp  
20 cm



**Cooley**

PSI-9-206-16

Anastomosis Clamp  
17 cm



**Cooley**

PSI-9-207-15

Multi purpose Vascular Clamp  
16 cm



**Cooley**

PSI-9-208-17

Multi purpose Vascular Clamp  
17 cm



**Cooley**

PSI-9-209-17

Multi purpose Vascular Clamp  
17 cm



**DeBakey**

**PSI-9-216-05**

Vascular Dilator  
19 cm



**Martin**

**PSI-9-217-00**

Tunneling Set complete set with three shafts, two handles and 12 tips in storage case.



**Hach**

**PSI-9-218-01**

Fasciotomy Knife with plastic handle  
30 cm



**Intima Spatula**

**PSI-9-219-18**

Intima Spatula  
18.5 cm

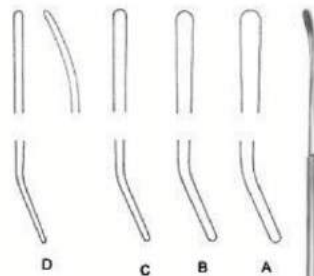

**Robb**

**PSI-9-220-01**

Vascular Dissector  
24 cm Fig. 1 2,5 mm ? , 24 cm Fig. 2 2,0 mm ?



**Crile**

**PSI-9-221-20**

Nerve Hooklet  
20 cm

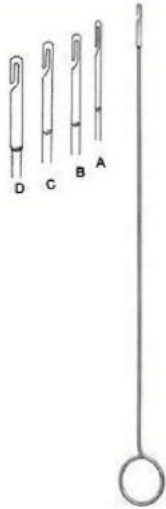

**Ligature Catcher**

**PSI-9-222-15**

Ligature Catcher  
26 cm 1,5 mm



**Subramanian-Miniature**

**PSI-9-223-15**

Aortic Clamp 135 degree  
15.5 cm

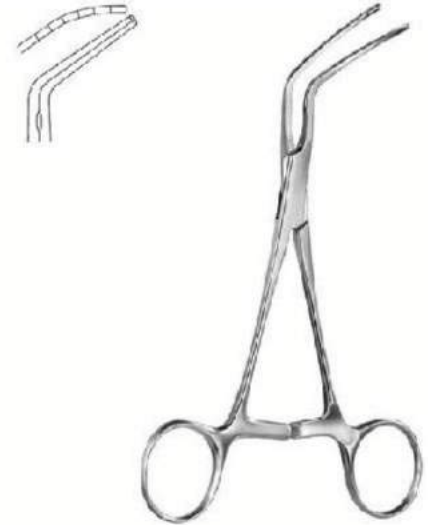

**Subramanian**

**PSI-9-224-16**

Aortic Clamp  
16 cm

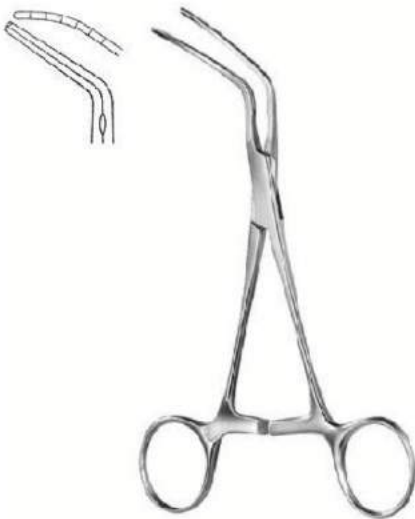

**Subramanian**

**PSI-9-225-16**

Aortic Clamp

14 cm Fig. 1, 14 cm Fig. 2, 14 cm Fig. 3

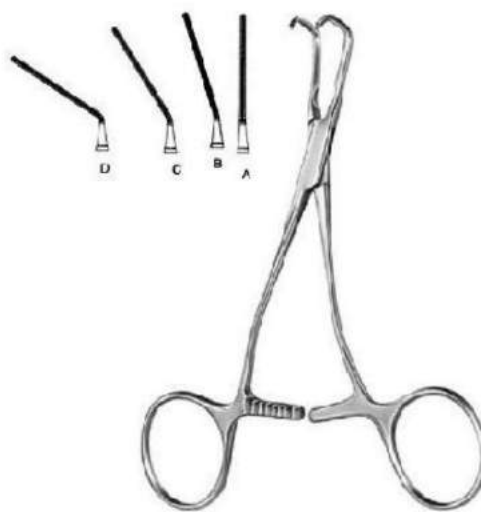

**Pediatric Vascular Clamp**

**PSI-9-226-01**

Pediatric Vascular Clamp



**Pediatric Vascular Clamp**

**PSI-9-227-16**

Pediatric Vascular Clamp

16.5 cm



**Pediatric Vascular Clamp**

**PSI-9-228-16**

Pediatric Vascular Clamp

16 cm



**Barraquer (Colibri)**

PSI-11-101-03

Barraquer  
Size 1



**Bowman**

PSI-11-102-07

Bowman  
Size 1



**Critchett**

PSI-11-103-06

Critchett  
Size 1

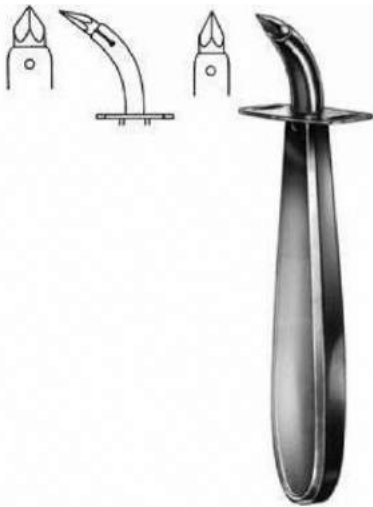

**Ueckermann**

**PSI-16-101-13**

Tracheotomy Trocar  
11.5 cm



**Iterson**

**PSI-16-102-16**

Tracheal Hook  
17 cm



**Rose**

**PSI-16-103-13**

Tracheal Hook  
13.5 cm



**Luer**

**PSI-16-104-11**

Tracheal Hook  
11 cm

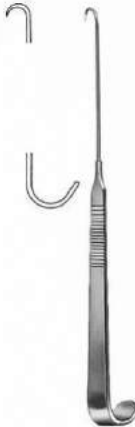

**Tracheal Hook**

**PSI-16-105-15**

Tracheal Hook  
15 cm



**Lukens**

**PSI-16-106-17**

Thymus Retractor  
17.5 cm



**Jackson**  
**PSI-16-107-17**  
 Tracheal Hook  
 18 cm



**Kocher**  
**PSI-16-108-15**  
 Goitre Enucleator  
 16.5 cm



**Kocher**  
**PSI-16-109-15**  
 Goitre Enucleator  
 16.5 cm



**Hofmeister**  
**PSI-16-110-21**  
 Goitre Enucleator  
 20.5 cm

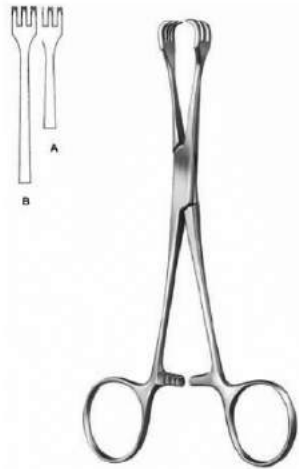

**Lahey**  
**PSI-16-111-15**  
 Goitre Grasping Forceps  
 15.5 cm



**Luer**  
**PSI-16-112-04**  
 Tracheal Tube



**Luer**

**PSI-6-113-08**

Tracheal Tube



**Chevalier-Jackson**

**PSI-16-114-04**

Tracheal Tube outer tube closed inner tube  
closed silver



**Speaking Tube**

**PSI-16-115-08**

Speaking Tube



**Moncorps**  
**PSI-17-101-14**  
 Milium Knife  
 14 cm



**Moncorps**  
**PSI-17-102-00**  
 Spare Blade



**Vidal**  
**PSI-17-103-14**  
 Lupus Scraper  
 13 cm



**Wolff**  
**PSI-17-105-01**  
 Lupus Curette  
 14 cm



**Kilner**  
**PSI-17-106-15**  
 Skin Hooklet  
 14.5 cm



**Gillies**  
**PSI-17-107-18**  
 Skin Hooklet  
 18 cm



**Kaye**  
**PSI-17-108-03**  
 Face-lift Hook  
 13 cm

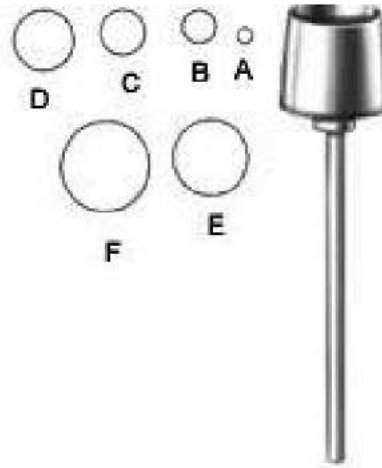

**Dermal Punch**  
**PSI-17-109-02**  
 Dermal Punch  
 5.5 cm



**Handle**  
**PSI-17-110-00**  
 Handle  
 8 cm

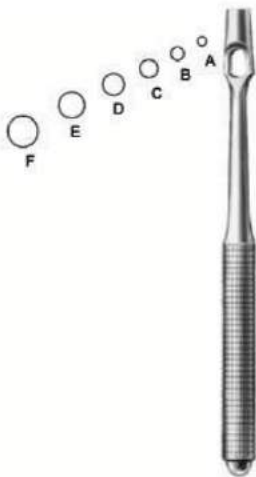

**Keyes**  
**PSI-17-111-02**  
 Dermal Punch  
 11 cm



**Unna**  
**PSI-17-113-14**  
 Comedone Extractor  
 14.5 cm



**Saalfeld**  
**PSI-17-114-10**  
 Comedone Extractor  
 11 cm



**Saalfeld**

**PSI-17-115-14**

Saalfeld Comedone Extractor  
14.5 cm



**Schamberg**

**PSI-17-116-10**

Comedone Extractor  
9.5 cm



**Katsch**

**PSI-17-117-14**

Comedone Extractor  
16 cm



**Unna-Vidal**

**PSI-17-118-11**

Comedone Extractor  
11.5 cm



**D'Assump?**

**PSI-17-119-15**

Face-lift Forceps  
18 cm



**Gregory**

**PSI-17-120-14**

Face-lift Scissors  
14 cm

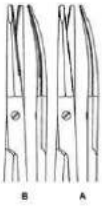

**Kaye**

**PSI-17-121-15**

Face-lift Scissors  
15 cm, 18 cm



**Stella-S**

**PSI-17-122-18**

Face-lift Scissors  
18 cm



**Gorney**

**PSI-17-123-18**

Face-lift Scissors  
18 cm



**Freeman-Kaye**

**PSI-17-124-18**

Face-lift Scissors  
18 cm



**Freeman**

**PSI-17-125-00**

Face-lift Scissors  
23 cm



**Fox**

**PSI-17-104-01**

Lupus Curette  
14 cm

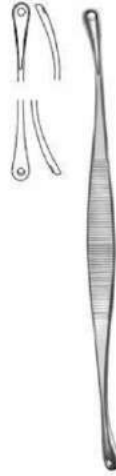

**Unna**

**PSI-17-112-14**

Comedone Extractor

14.5 cm



**Allis-Baby**

**PSI-18-101-12**

Intestinal and Tissue Grasping Forceps  
13 cm

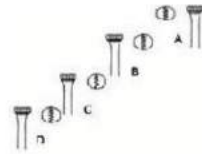

**Allis**

**PSI-18-102-15**

Intestinal and Tissue Grasping Forceps  
15.5 cm, 19 cm, 25.5 cm



**Allis**

**PSI-18-103-16**

Intestinal and Tissue Grasping Forceps  
15.5 cm, 20 cm, 24.5 cm, 30 cm



**Allis-Adair**

**PSI-18-104-15**

Intestinal and Tissue Grasping Forceps  
16 cm



**Boys-Allis**

**PSI-18-105-15**

Intestinal and Tissue Grasping Forceps  
15.5 cm



**Thoms-Allis**

**PSI-18-106-20**

Intestinal and Tissue Grasping Forceps  
20.5 cm



**Allis**

**PSI-18-107-20**

Intestinal and Tissue Grasping Forceps  
20 cm



**Lockwood**

**PSI-18-108-20**

Intestinal and Tissue Grasping Forceps  
20 cm



**Williams**

**PSI-18-109-16**

Intestinal and Tissue Grasping Forceps  
16.5 cm

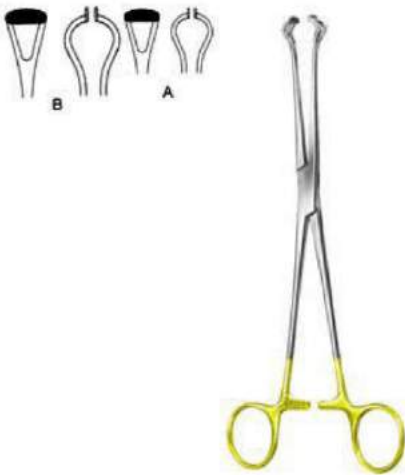

**Babcock**

**PSI-18-110-16**

Intestinal and Tissue Grasping Forceps  
16.5 cm, 21 cm



**Babcock**

**PSI-18-111-16**

Intestinal and Tissue Grasping Forceps  
15.5 cm, 17.5 cm, 21 cm, 24 cm

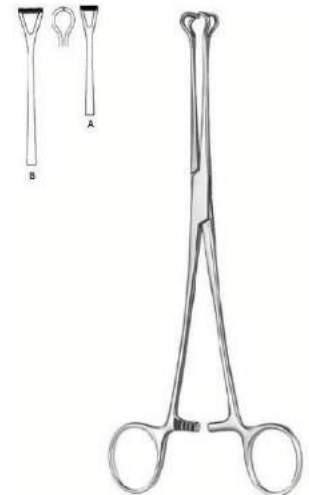

**Babcock**

**PSI-18-112-16**

Intestinal and Tissue Grasping Forceps  
16.5 cm, 25.5 cm



**Duval**

**PSI-18-113-20**

Intestinal and Tissue Grasping Forceps  
20.5 cm



**Duval**

**PSI-18-114-18**

Intestinal and Tissue Grasping Forceps  
18 cm, 25.5 cm, 23 cm

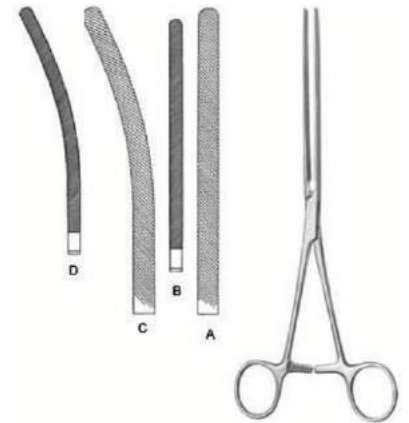

**Doyen**

**PSI-18-115-21**

Intestinal Clamp  
21.5 cm, 23.5 cm



**Doyen-Baby**

**PSI-18-116-18**

Intestinal Clamp  
18 cm, 17.5 cm



**Mayo-Robson**

**PSI-18-117-21**

Intestinal Clamp  
21.5 cm, 23.5 cm, 23 cm

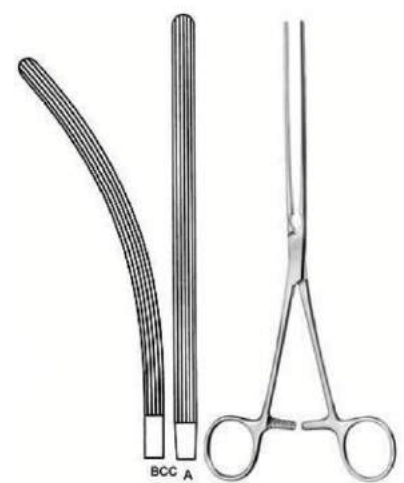

**Mayo-Robson**

**PSI-18-118-25**

Intestinal Clamp  
25.5 cm, 24.5 cm

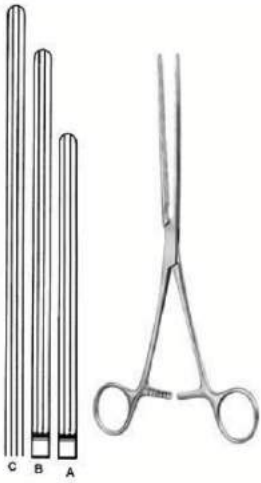

**Kocher**

**PSI-18-119-22**

Intestinal Clamp

22.5 cm, 25 cm, 28.5 cm

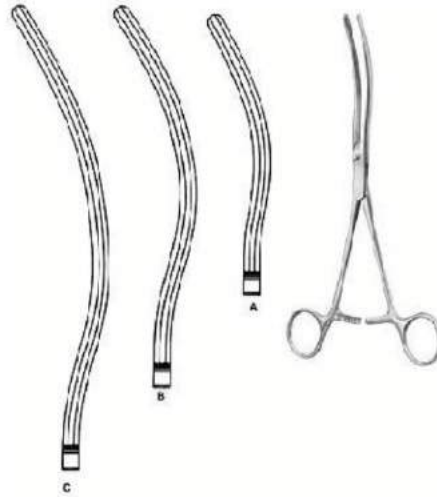

**Kocher**

**PSI-18-120-22**

Intestinal Clamp

22 cm, 24.5 cm, 27.5 cm



**Allen**

**PSI-18-121-16**

Intestinal Clamp

16 cm



**Payr-Baby**

**PSI-18-122-15**

Intestinal and Pylorus Clamp

15 cm

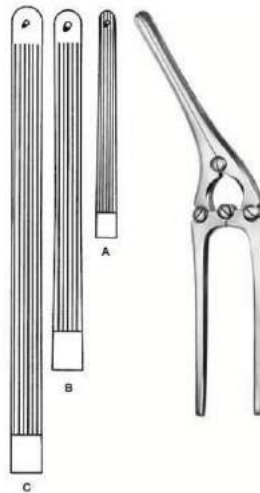

**Payr**

**PSI-18-123-21**

Intestinal and Pylorus Clamp

20.5 cm, 29 cm, 34.5 cm



**Stone-Watt**

**PSI-18-124-07**

Intestinal Anastomosis Clamp

8.5 cm, 10 cm



**Stone-Watt**  
**PSI-18-125-15**  
 Closing Forceps

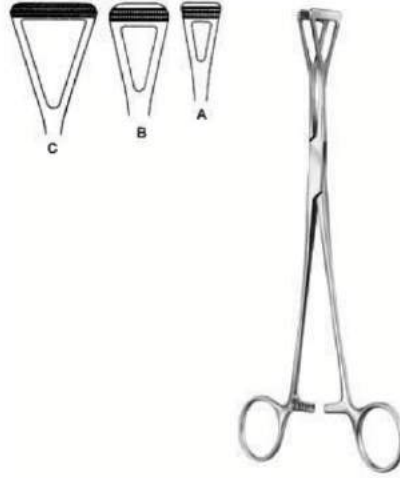

**Scheibe**  
**PSI-18-126-18**  
 Organ Grasping Forceps  
 18 cm

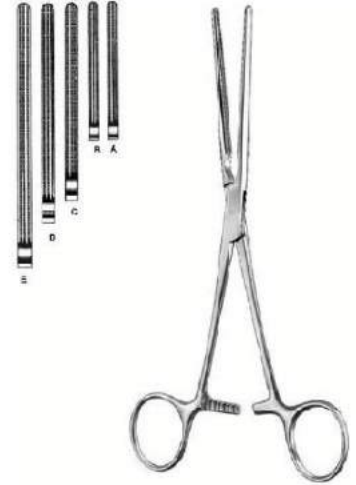

**Doyen-Baby**  
**PSI-18-127-13**  
 Intestinal Clamp  
 14 cm, 17 cm

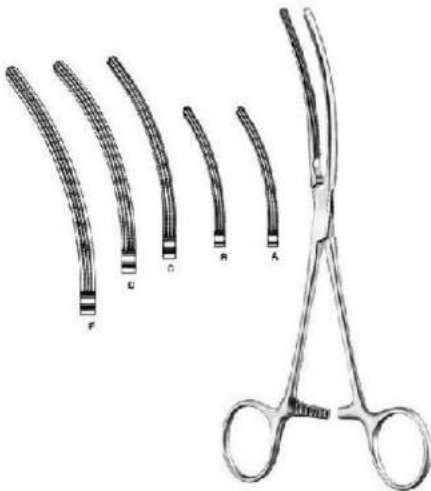

**Doyen-Baby**  
**PSI-18-128-13**  
 Intestinal Clamp  
 13.5 cm , 17 cm



**Mayo-Robson**  
**PSI-18-129-25**  
 Intestinal Clamp  
 26 cm



**Mayo-Robson**  
**PSI-18-130-25**  
 Intestinal Clamp  
 25 cm



**Kocher**

**PSI-18-131-22**

Intestinal Clamp  
22.5 cm, 28 cm



**Kocher**

**PSI-18-132-22**

Intestinal Clamp  
22 cm, 25 cm, 27.5 cm

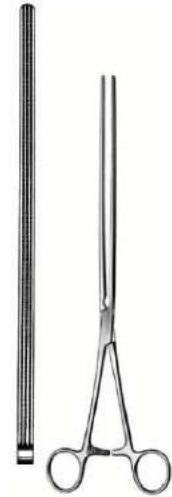

**Scudder**

**PSI-18-133-33**

Intestinal Clamp  
33.5 cm

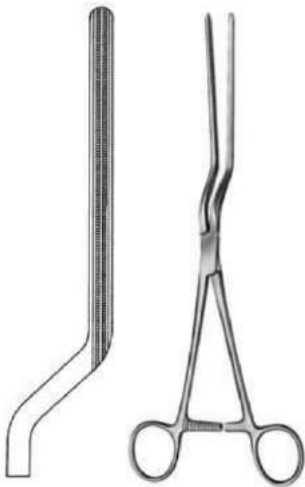

**Brunner**

**PSI-18-134-24**

Sigmoid Anastomosis Forceps  
27 cm

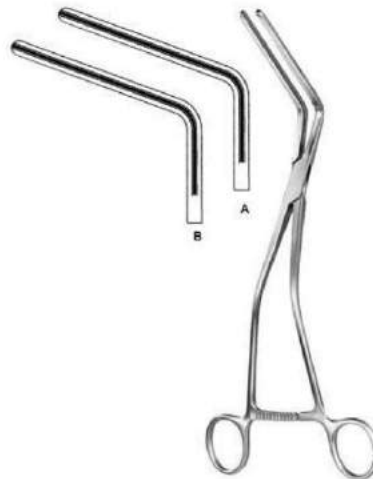

**Hayes**

**PSI-18-135-26**

Sigmoid Anastomosis Forceps  
27 cm, 28 cm



**Veidenheimer**

**PSI-18-136-23**

Sigmoid Anastomosis Forceps  
25 cm



**Fehland**

**PSI-18-137-24**

Sigmoid Anastomosis Forceps  
24 cm

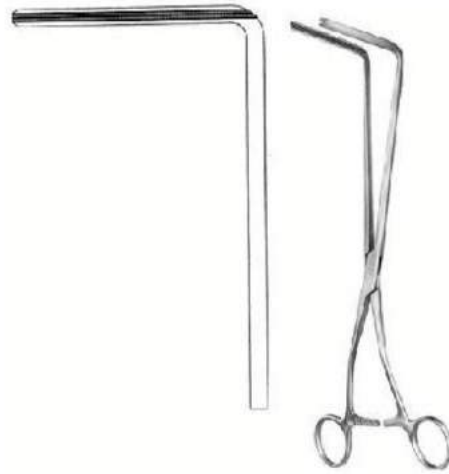

**Resano**

**PSI-18-138-30**

Sigmoid Anastomosis Forceps  
28 cm



**Sims**

**PSI-18-139-15**

Rectal Speculum  
15.5 cm



**Sims**

**PSI-18-140-15**

Rectal Speculum  
15.5 cm



**Mathieu**

**PSI-18-141-19**

Rectal Speculum  
19 cm



**Alan-Parks**

**PSI-18-142-00**

Alan-Parks  
14 cm

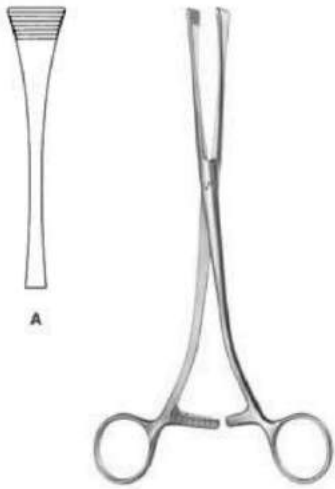

**Green-Armytage**

**PSI-21-107-21**

Uterine Clamp  
21 cm



**Sellheim**

**PSI-21-108-28**

Obstetrical Lever  
32 cm

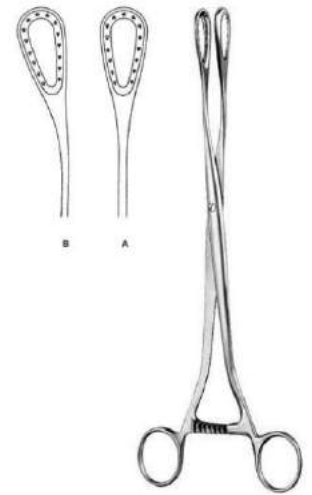

**Sanger**

**PSI-21-109-27**

Placenta and Ovum Forceps  
27.5 cm, 27 cm

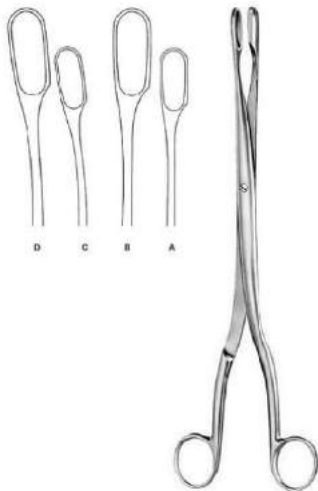

**Winter**

**PSI-21-110-01**

Placenta and Ovum Forceps  
28 cm Fig. 1, 28 cm Fig. 2

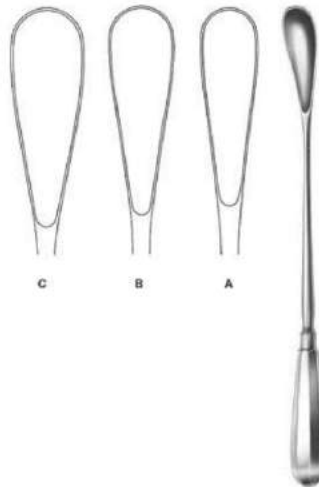

**Cuzzi**

**PSI-21-111-01**

Placenta Scoop  
30 cm 14,5 mm, 30 cm 18 mm



**Pestaloza**

**PSI-21-112-30**

Placenta Scoop  
30 cm



**McGinvey**

**PSI-18-143-19**

Hemorrhoidal Grasping Forceps  
19 cm



**Handle For Biopsy Forceps**

**PSI-18-144-00**

Handle for biopsy forceps



**Rectal Biopsy Forceps**

**PSI-18-145-38**

Rectal Biopsy Forceps

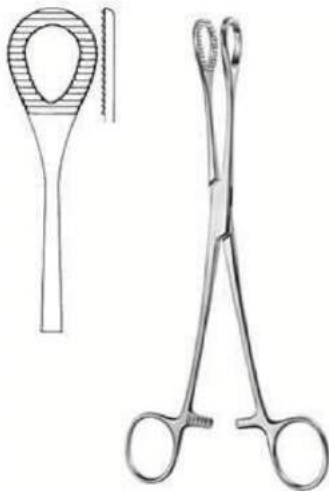

**Heywood-Smith**

**PSI-18-146-21**

Polypus Grasping Forceps  
21 cm

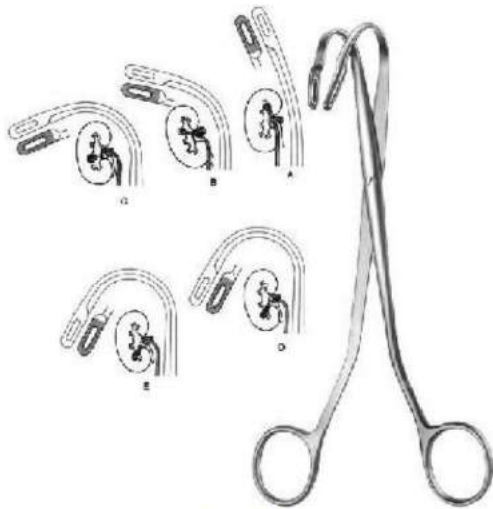

**Randall**

**PSI-19-101-23 A**

Kidney Stone Forceps

23 cm Fig. 1 , 21 cm Fig. 2, 21 cm Fig. 3



**Randall**

**PSI-19-102-23 A**

Kidney Stone Forceps

23 cm , 24.5 cm

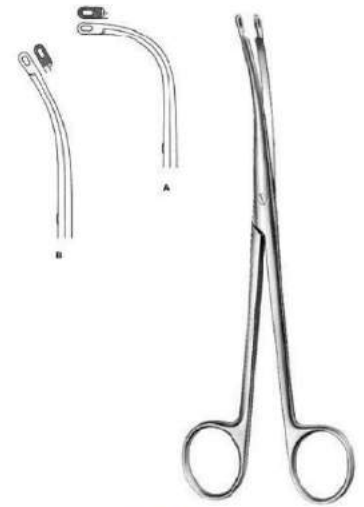

**Heiming**

**PSI-19-103-16 A**

Kidney Stone Forceps

16 cm Fig. 1, 17 cm Fig. 2

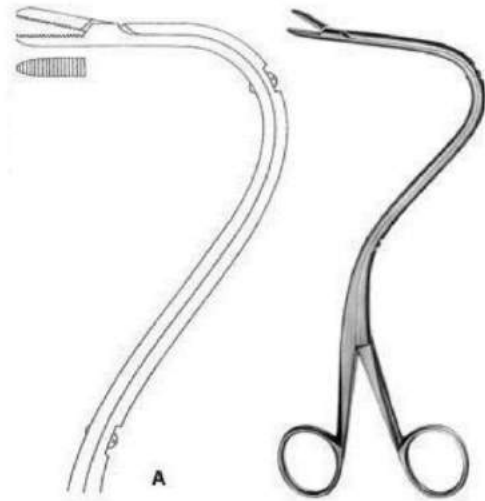

**Elsasser**

**PSI-19-104-01 A**

Nephrostomy Forceps

21 cm Fig. 1 , 21 cm Fig. 2



**Bakes**

**PSI-19-105-01 A**

Gall Duct Dilator

32 cm

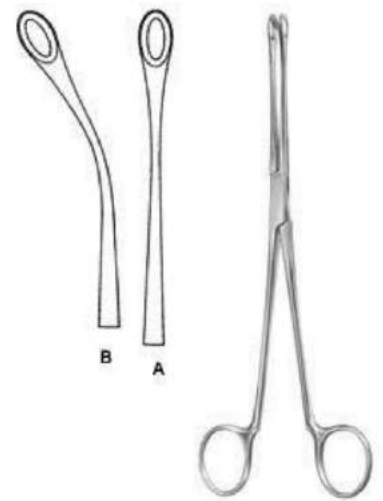

**Blake**

**PSI-19-106-20 A**

Gall Stone Forceps

21 cm



**Mayo-Blake**

**PSI-19-107-20**

Gall Stone Forceps  
21 cm



**Mayo-Blake**

**PSI-19-108-20**

Gall Stone Forceps  
21 cm



**Mixer**

**PSI-19-109-22**

Gall Stone Forceps  
21.5 cm



**Desjardins**

**PSI-19-110-23 A**

Gall Stone Forceps  
23 cm

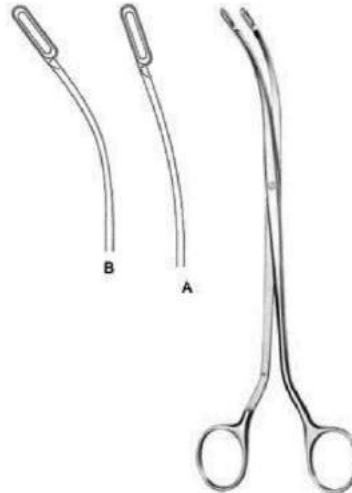

**Desjardins**

**PSI-19-111-24 A**

Gall Stone Forceps



**Luer-Korte**

**PSI-19-112-01 A**

Gall Stone Scoop  
32 cm Fig. 0 , 32 cm Fig. 00 , 32 cm Fig. 000 , 32 cm Fig. 1, 32 cm Fig. 2, 32 cm Fig. 3, 32 cm Fig. 4

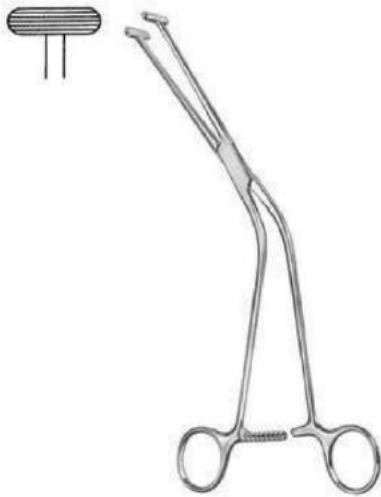

**Millin**  
**PSI-19-119-23**  
 Capsule Forceps  
 24.5 cm



**Millin**  
**PSI-19-120-23**  
 Capsule Forceps  
 22 cm

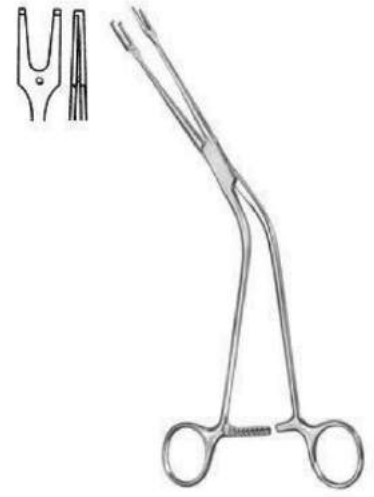

**Millin**  
**PSI-19-121-24**  
 Ligature Carrying Forceps  
 24.5 cm



**Millin**  
**PSI-19-122-00**  
 Bladder Neck Spreader  
 29



**Thomson-Walker**  
**PSI-19-123-00**  
 Bladder Retractor



**Judd-Masson**  
**PSI-19-124-00**  
 Bladder Retractor

# MADNI



IMPEX

✉ madniimpex3@gmail.com

SURGICAL INSTRUMENTS

Urology



**Millin**

**PSI-19-125-00 A**

Bladder Retractor



**Legueu**

**PSI-19-126-27**

Bladder Spatula  
24 cm , 35 mm

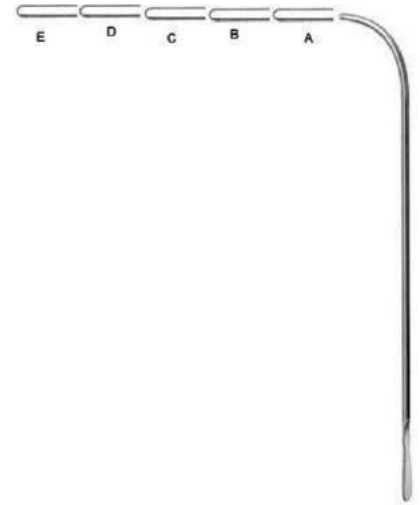

**Van Buren**

**PSI-19-127-00 A**

Urethral Sound  
27.5 cm

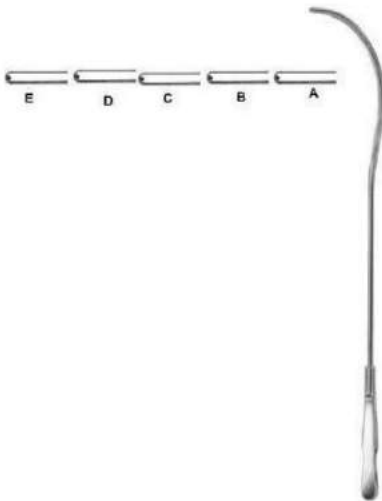

**Guyon**

**PSI-19-128-10 A**

Urethral Sound  
26 cm



**Cusco**

**PSI-20-101**

Vaginal Speculum  
75 x 32 mm, 85 x 35 mm



**Cusco**

**PSI-20-102-01**

Vaginal Speculum  
75 x 18 mm



**Cusco**

**PSI-20-103-01**

Vaginal Speculum  
80 x 22 mm, 100 x 25 mm, 105 x 27 mm



**Cusco**

**PSI-20-104-01**

Vaginal Speculum  
75 x 34 mm, 85 x 37 mm



**Collin**

**PSI-20-105-01**

Vaginal Speculum  
85 x 30 mm, 100 x 35 mm



**Pederson**

**PSI-20-106-01**

Vaginal Speculum  
75 x 13 mm, 100 x 22 mm



**Grave**

**PSI-20-107-01**

Vaginal Speculum

75 x 20 mm, 95 x 35 mm



**Semm**

**PSI-20-108-01**

Vaginal Speculum

100 x 20 mm, 105 x 27 mm



**Sims**

**PSI-20-109-01**

Vaginal Speculum

65 x 25 mm, 70 x 30 mm



**Kristeller**

**PSI-20-110-01**

Vaginal Speculum

70 x 27 mm



**Kristeller**

**PSI-20-111-01**

Vaginal Retractor

75 x 23 mm



**Kristeller**

**PSI-20-112-01**

Vaginal Speculum

Size 1



**Kristeller**

**PSI-20-113-01**

Vaginal Speculum  
105 x 18 mm



**Kristeller**

**PSI-20-114-01**

Vaginal Retractor  
110 x 14 mm



**Kristeller**

**PSI-20-115-01**

Vaginal Speculum  
Size 1

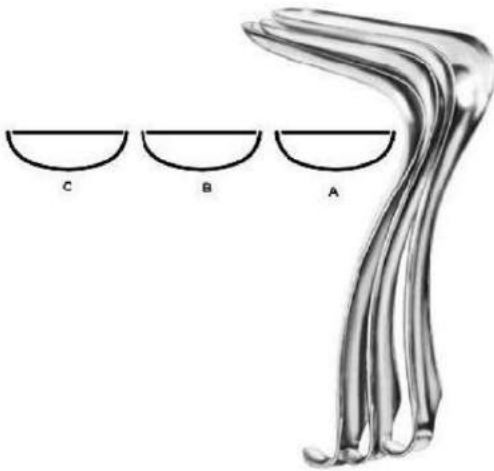

**Kristeller**

**PSI-20-116-01**

Vaginal Speculum  
105 x 26 mm

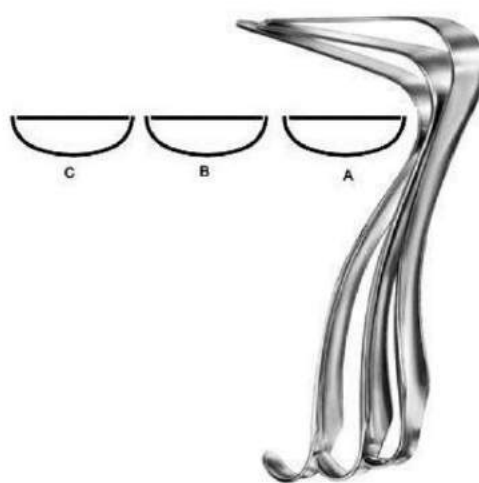

**Kristeller**

**PSI-20-117-01**

Vaginal Retractor  
115 x 22 mm, 115 x 23 mm



**Kristeller**

**PSI-20-118-01**

Vaginal Speculum  
Size 1



**Auvard**  
**PSI-20-126-22**  
 Vaginal Speculum  
 80 x 43 mm



**Weissbarth**  
**PSI-20-127-24**  
 Vaginal Speculum  
 21 cm 80 x 42 mm



**Breisky**  
**PSI-20-128-20**  
 Vaginal Speculum  
 29 cm 100 x 20 mm, 29 cm 100 x 25 mm



**Kogan**  
**PSI-20-129-24**  
 Endocervical Speculum  
 25 cm 70 x 30 mm



**Kogan**  
**PSI-20-130-24**  
 Endocervical Speculum  
 24.5 cm



**Hegar**  
**PSI-20-131-24**  
 Uterine Dilator  
 18.5 cm 1,0



### Hegar

PSI-20-132-02

Uterine Dilator  
20 cm 1,0



### Hank

PSI-20-133-10

Uterine Dilator  
26.5 cm Fig. 9/10



### Sims

PSI-20-134-32

Uterine Sound  
33 cm



### Valleix

PSI-20-135-25

Uterine Sound  
29.5 cm



### Braun

PSI-20-136-26

Uterine Depressor  
27.5 cm



### Schroder

PSI-20-137-25

Uterine Tenaculum Forceps  
25.5 cm



**Braun**

**PSI-20-138-25**

Uterine Tenaculum Forceps  
26 cm



**Duplay**

**PSI-20-139-28**

Uterine Tenaculum Forceps  
25.5 cm



**Beacham**

**PSI-20-140-26**

Amniotome  
26 cm



**Skene**

**PSI-20-141-24**

Uterine Tenaculum Forceps  
24 cm

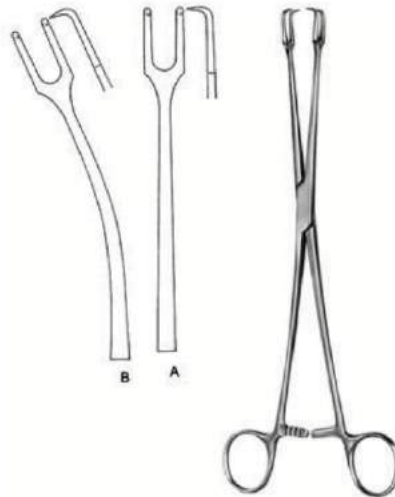

**Schroder**

**PSI-20-142-24**

Uterine Tenaculum Forceps  
25 cm



**Teale**

**PSI-20-143-23**

Uterine Tenaculum Forceps  
23.5 cm



**Iowa**

**PSI-20-144-26**

Uterine Tenaculum Forceps  
26 cm

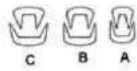

**Museux**

**PSI-20-145-24**

Uterine Tenaculum Forceps  
24 cm



**Jacobs**

**PSI-20-146-21**

Uterine Tenaculum Forceps  
21 cm

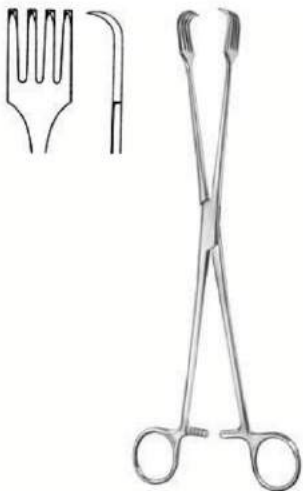

**Uterine Tenaculum Forcep**

**PSI-20-147-26**

Uterine Tenaculum Forcep  
26.5 cm



**Braun**

**PSI-20-148-16**

Uterine Tenaculum Forceps  
16 cm

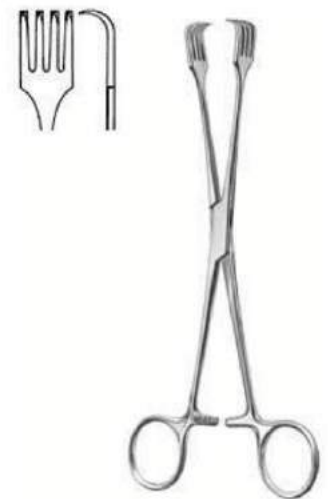

**Czerny**

**PSI-20-149-21**

Uterine Tenaculum Forceps  
21 cm



**Kelly**

**PSI-20-150-32**

Uterine Polypus Forceps  
32 cm



**Noto**

**PSI-20-151-27**

Uterine Polypus Forceps  
27 cm

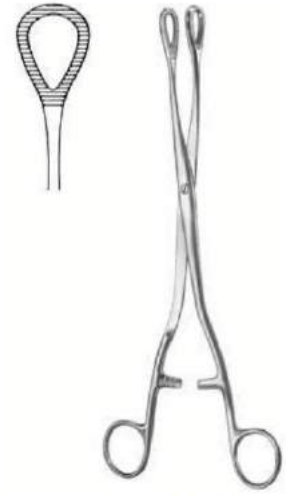

**Heywood-Smith**

**PSI-20-152-25**

Uterine Polypus Forceps  
25 cm



**Doyen**

**PSI-20-153-17**

Myoma Screw  
17 cm



**Doyen**

**PSI-20-154-17**

Myoma Screw  
14.5 cm



**Segond**

**PSI-20-155-27**

Myoma Knife  
28 cm



**Dartigues**

**PSI-20-156-27**

Uterine Seizing Forceps

28 cm



**Somer**

**PSI-20-157-27**

Uterine Seizing Forceps

22.5 cm



**Collin**

**PSI-20-158-25**

Uterine Seizing Forceps jaw 40 mm wide

26 cm



**Ayre**

**PSI-20-159-23**

Conization Knife cutting edge 3,6 mm wide

23.5 cm



**Emmett**

**PSI-20-160-03**

Fistula Hook

22 cm Fig.3



**Simon**

**PSI-20-161-22**

Fistula Hook

21.5 cm



**Schubert**

**PSI-20-168-21**

Uterine Biopsy Forceps jaw 4,8 mm wide  
21.5 cm, 28 cm

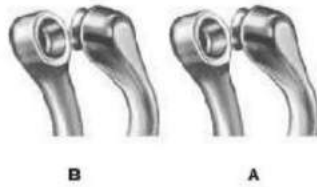

**Thoms-Gaylor**

**PSI-20-169-22**

Uterine Biopsy Forceps jaw 5,6 mm ?  
21 cm, 23.5 cm

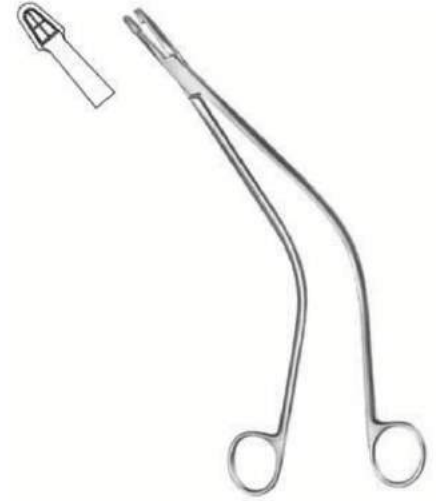

**Schubert**

**PSI-20-170-26**

Schubert Uterine Biopsy Forceps  
25.5 cm

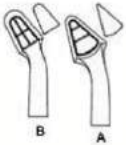

**Van Doren**

**PSI-20-171-24**

Uterine Biopsy Forceps jaw 4,9 mm wide  
27 cm, 25.5 cm



**Alexander**

**PSI-20-172-28**

Uterine Biopsy Forceps jaw 5,1 mm wide  
28 cm



**Kevorkian**

**PSI-20-173-32**

Uterine Biopsy Forceps  
25 cm

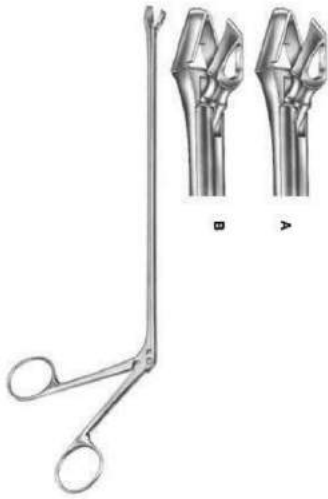

**Schumacher**

**PSI-20-174-01**

Uterine Biopsy Forceps jaw 4,6 / 5,4 mm wide  
24 cm



**Schumacher**

**PSI-20-175-00**

Uterine Biopsy Forceps  
25 cm



**IUP Grasping Forceps 3 Mm ?**

**PSI-20-176-22**

IUP Grasping Forceps 3 mm ?  
22 cm

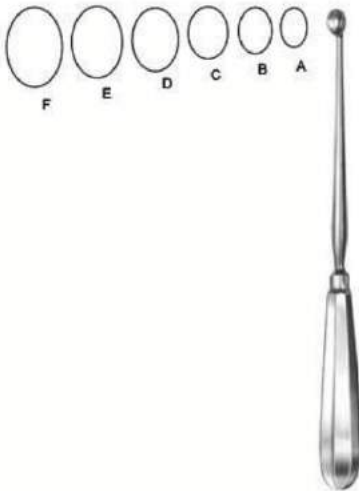

**Simon**

**PSI-20-177-01**

Uterine Scoop  
24.5 cm 9,8 x 8,6 mm, 24.5 cm 11,6 x 8,3 mm



**Simon**

**PSI-20-178-01**

Uterine Scoop  
30 cm 9,8 x 8,6 mm, 30 cm 11,6 x 8,3 mm



**Recamier**

**PSI-20-179-05**

Uterine Curette  
31 cm Fig. 00 5 mm, 31 cm Fig. 0 6 mm



**Martin**

**PSI-21-101-34**

Pelvimeter cm, inch scale  
34 cm



**Nagele**

**PSI-5-102-36**

Obstetrical Forceps  
35 cm, 40.5 cm



**Simpson**

**PSI-5-103-30**

Obstetrical Forceps  
31 cm



**Wrigley**

**PSI-5-104-28**

Obstetrical Forceps  
28 cm



**Simpson**

**PSI-21-105-36**

Obstetrical Forceps  
36.5 cm



**Kielland**

**PSI-21-106-41**

Obstetrical Forceps  
42 cm



**Recamier**

**PSI-20-180-05**

Uterine Curette

31 cm Fig. 00 5 mm, 31 cm Fig. 0 6 mm



**Sims**

**PSI-20-181-05**

Uterine Curette

31 cm Fig. 00 5 mm, 31 cm Fig. 0 6 mm



**Sims**

**PSI-20-182-05**

Uterine Curette

31 cm Fig. 00 5 mm, 31 cm Fig. 0 6 mm



**Suction Curette**

**PSI-0-183-03**

Suction Curette

29 cm 3,0 mm ?, 29 cm 4,5 mm ?, 29 cm 6,0 mm ?



**Williger**

PSI-7-170-01

Mallet

16.5 cm



**Mead**

PSI-7-171-17

Mallet

19 cm



**Partsch**

PSI-7-172-18

Mallet

19 cm

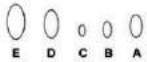

**Schede**

PSI-7-173-01

Bone Curette Fig. 0 to 4

17 cm



**Kahre-Williger**

PSI-7-201-04

Periosteal Elevator

4 mm, 5 mm, 7 mm



**Periosteal Elevator**

PSI-7-202-06

Periosteal Elevator

17 cm 6mm , 17 cm 8mm

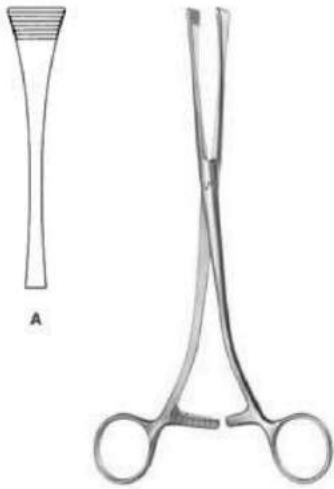

**Green-Armytage**

**PSI-21-107-21**

Uterine Clamp  
21 cm



**Sellheim**

**PSI-21-108-28**

Obstetrical Lever  
32 cm

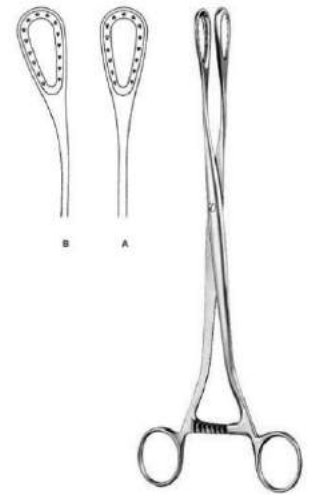

**Sanger**

**PSI-21-109-27**

Placenta and Ovum Forceps  
27.5 cm, 27 cm

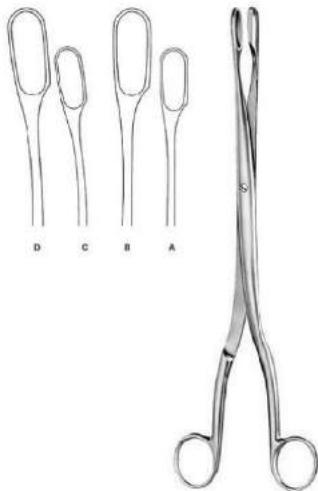

**Winter**

**PSI-21-110-01**

Placenta and Ovum Forceps  
28 cm Fig. 1, 28 cm Fig. 2

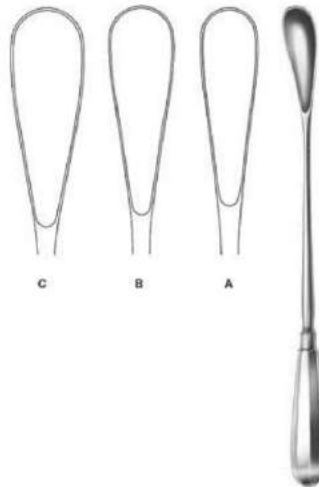

**Cuzzi**

**PSI-21-111-01**

Placenta Scoop  
30 cm 14,5 mm, 30 cm 18 mm



**Pestaloza**

**PSI-21-112-30**

Placenta Scoop  
30 cm



**Kane**

**PSI-21-113-08**

Umbilical Cord Clamp  
8.5 cm



**Collin**

**PSI-21-114-09**

Umbilical Cord Clamp  
8.5 cm



**Irrigator**

**PSI-23-101-10**

Sterilization  
Size 1



**Round Bowl**

**PSI-23-102-16**

Sterilization  
220 mm x 70 mm, 400 mm x 150 mm



**Round Bowl**

**PSI-23-103-33**

Sterilization  
? x h 6,00 l



**Flat Dish**

**PSI-23-104-11**

Sterilization  
? x h 0,20 l



**Lid Only**

**PSI-23-105-11**

Sterilization  
Size 1



**Stainless Steel**

**PSI-23-106-04**

Sterilization  
? x h 0,30 l



**Round Dish**

**PSI-23-107-11**

Sterilization

? x h 0,30 l, ? 128 x 38 mm 0,40 l



**Flat Dish**

**PSI-23-108-11**

Sterilization

? x h 0,15 l



**Measurer**

**PSI-23-109-01**

Graduated inside

100cc = 0,1 l



**Measurer**

**PSI-23-110-02**

Graduated Inside

0,25 l, 0,50 l



**Petri Dish**

**PSI-23-111-10**

with Lid ? x h



**Petri Dish**

**PSI-23-112-09**

without lid ? x h

Size 1



**Lid For Petri Dishes**

**PSI-23-113-10**

Sterilization  
Size 1



**Universal Tray**

**PSI-23-114-23**

Sterilization  
l x b x h



**Instrument Tray**

**PSI-23-115-21**

Sterilization  
l x b x h



**Universal Tray**

**PSI-23-116-23**

Sterilization  
l x b x h



**Round Bowl**

**PSI-23-117-22**

Sterilization  
? x h



**Metal Jar**

**PSI-23-118-30**

Sterilization  
? 30mm x 90 mm, ? 50mm x 100 mm



**Instrument Box**

**PSI-23-119-16**

lid with knob  
l x b x h



**Instrument Box**

**PSI-23-120-16**

lid with knob  
l x b x h



**Instrument Box**

**PSI-23-121-20**

Sterilization  
l x b x h



**Round Metal Box**

**PSI-23-122-06**

Sterilization  
? 75 mm x 75 mm, ? 100 mm x 60 mm



**Medicine Cup Graduated Inside**

**PSI-23-123-25**

Sterilization  
25 cm



**Medicine Cup Graduated Inside**

**PSI-23-124-50**

Sterilization  
50 cm



**Tablet Tray**

**PSI-23-125-75**

Sterilization  
? 75 mm x 12 mm



**Metal Cup**

**PSI-23-126-90**

Sterilization  
? 90 mm x 90 mm



**Denture Cup**

**PSI-23-127-75**

Sterilization  
? 75 mm x 50 mm



**Insert For Cup**

**PSI-23-128-75**

Sterilization  
? 73 mm x 75 mm



**Kidney Dish**

**PSI-23-129-17**

Kidney Dish  
l x b x h



**Placenta Pan**

**PSI-23-130-36**

Sterilization  
Size 1



**Charri?Re**

**PSI-7-102-35**

Amputation Saw  
35 cm



**Langenbeck**

**PSI-7-103-23**

Amputation Saw  
24.5 cm



**Charriere**

**PSI-7-104-27**

Amputation Saw  
26.5 cm



**Reamer**

**PSI-7-105-14**

Reamer  
13.5 cm



**Perthes**

**PSI-7-106-18**

Reamer  
18 cm



**Perthes**

**PSI-7-107-21**

Reamer  
21.5 cm



**Reamer**  
**PSI-7-108-14**  
 Reamer  
 14 cm



**Flat Trephine**  
**PSI-7-111-18**  
 Flat Trephine



**Wire Twisting Forceps**  
**PSI-7-112-01**  
 Wire Twisting Forceps  
 15.5 cm, 18 cm, 20 cm

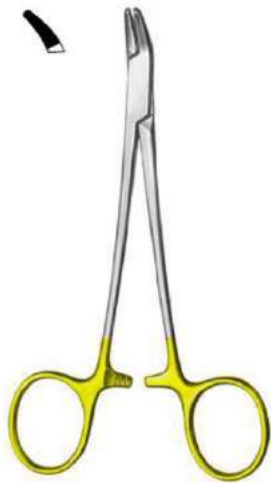

**Wire Twisting Forceps**  
**PSI-7-113-15**  
 Wire Twisting Forceps  
 15.5 cm



**Flat Nose Plier**  
**PSI-7-114-17**  
 Flat Nose Plier  
 18.5 cm



**Wire Twisting Forceps**  
**PSI-7-115-18**  
 Wire Twisting Forceps  
 19 cm



**Combi-Flat Nose Plier**

**PSI-7-116-15**

Combi-Flat Nose Plier  
15 cm



**Flat Nose Plier**

**PSI-7-117-01**

Flat Nose Plier  
18 cm

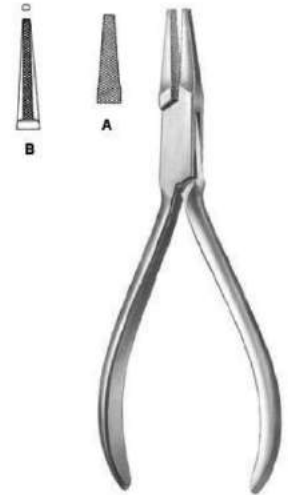

**Flat Nose Plier**

**PSI-7-118-14**

Flat Nose Plier  
13.5 cm



**Hackstock**

**PSI-7-119-16**

Flat Nose Plier  
16 cm



**Flat Nose Plier**

**PSI-7-120-01**

Flat Nose Plier  
17.5 cm



**Wire Cutting Pliers**

**PSI-7-121-18**

Wire Cutting Pliers  
18.5 cm



**Wire Cutting Pliers**  
**PSI-7-122-15**  
 Wire Cutting Pliers  
 15 cm



**Wire Cutting Pliers**  
**PSI-7-123-18**  
 Wire Cutting Pliers  
 17.5 cm



**Demel**  
**PSI-7-124-18**  
 Wire Guide  
 28 cm Fig. 3 , 29 cm Fig. 2 , 31 cm Fig. 1

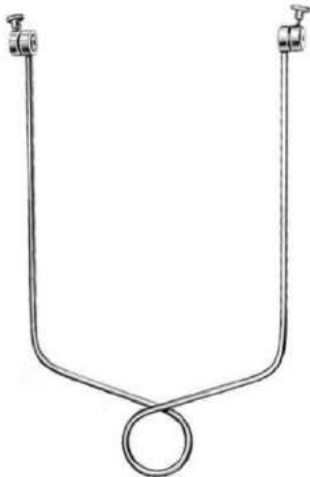

**Bohler**  
**PSI-7-125-15**  
 Extension Bow



**Kirschner**  
**PSI-7-126-01**  
 Extension Bow  
 18.5 cm , 26.5 cm



**Traction Hook For Extension Bows**  
**PSI-7-127-06**  
 Traction Hook for Extension Bows



**Kirschner**  
**PSI-7-128-06**  
 Wire Drill  
 6 cm, 12 cm



**Kirschner**  
**PSI-7-129-06**  
 Wire Drill  
 14 cm, 16 cm



**Kirschner**  
**PSI-7-130-10**  
 Wire Drill  
 31 cm



**Kirschner**  
**PSI-7-131-10**  
 Wire Drill  
 12 cm, 16 cm, 18 cm



**Kirschner**  
**PSI-7-132-10**  
 Wire Drill  
 31 cm



**Buckley**  
**PSI-7-133-02**  
 Chisel  
 16 cm



**Buckley**  
**PSI-7-134-02**  
 Gouge  
 16 cm



**Stout**  
**PSI-7-135-03**  
 Bone Chisel  
 21 cm



**Bone Chisel**  
**PSI-7-112-01**  
 Bone Chisel  
 18 cm



**Bone Chisel**  
**PSI-7-137-04**  
 Bone Chisel  
 18 cm



**Bone Chisel**  
**PSI-138-04**  
 Bone Chisel  
 17 cm



**Bone Chisel**  
**PSI-7-139-04**  
 Bone Chisel  
 17 cm

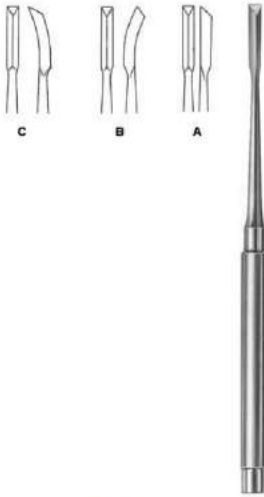

**Gardner**

**PSI-7-112-01**

Bone Chisel  
17 cm 4mm



**Snyder-O.S.U.**

**PSI-7-141-03**

Bone Chisel  
16.5 cm 3mm , 16.5 cm 5.5mm



**O.S.U.**

**PSI-7-142-01**

one Chisel  
17 cm 7mm



**O.S.U.**

**PSI-7-143-01**

One Chisel  
17 cm 9mm



**Osteotome**

**PSI-7-144-08**

Osteotome  
13.5 cm 8mm , 13.5 cm 10mm , 13.5 cm 12mm ,  
13.5 cm 14mm , 13.5 cm 16mm



**Chisel**

**PSI-7-145-08**

Chisel  
13.5 cm 8mm , 13.5 cm 10mm , 13.5 cm 12mm ,  
13.5 cm 14mm , 13.5 cm 16mm



**Gouge**

**PSI-7-146-08**

Gouge

13.5 cm 8mm , 13.5 cm 10mm , 13.5 cm 12mm ,  
13.5 cm 14mm , 13.5 cm 16mm



**Partsch**

**PSI-7-147-02**

Chisel

13.5 cm 2mm, 13.5 cm 3mm , 13.5 cm 4mm , 13.5  
cm 5mm , 13.5 cm 6mm , 17 cm 2mm , 17 cm  
3mm , 17 cm 4mm , 17 cm 5mm , 17 cm 6mm



**Partsch**

**PSI-7-148-02**

Gouge

13.5 cm 2mm, 13.5 cm 3mm , 17 cm 2mm , 17 cm  
3mm



**Stille**

**PSI--7-149**

Chisel

20 cm 10mm , 20 cm 15mm , 20 cm 20mm , 20  
cm 25mm



**Stille**

**PSI--7-150**

O

20 cm 10mm , 20 cm 15mm , 20 cm 20mm , 20  
cm 25mm



**Stille**

**PSI-7-151-10**

Gouges

20 cm 10mm , 20 cm 15mm , 20 cm 20mm , 20  
cm 25mm



**Lambotte, Mini**

**PSI-7-152-02**

Osteotome

12.5 cm 2mm , 12.5 cm 3mm , 12.5 cm 4mm ,  
12.5 cm 6mm



**Lambotte**

**PSI-7-153-15**

Osteotome

24 cm 15mm , 24 cm 20mm , 24 cm 25mm , 24  
cm 30mm



**Lambotte**

**PSI-7-154-15**

Osteotome

24 cm 15mm , 24 cm 20mm , 24 cm 25mm , 24  
cm 30mm



**Smith-Petersen**

**PSI-7-155-06**

Osteotome

20.5 cm 6mm , 20.5 cm 9mm , 20.5 cm 13mm



**Smith-Petersen**

**PSI-7-156-06**

Osteotome

20.5 cm 6mm , 20.5 cm 9mm , 20.5 cm 13mm ,  
20.5 cm 16mm , 20.5 cm 19mm



**Smith-Petersen**

**PSI-7-157-09**

Gouge

20.5 cm 9mm , 20.5 cm 14mm , 20.5 cm 19mm ,  
20.5 cm 25mm



**Hibbs**

PSI-7-164-06

Gouge

24.5 cm 6mm , 24.5 cm 13mm , 24.5 cm 19mm

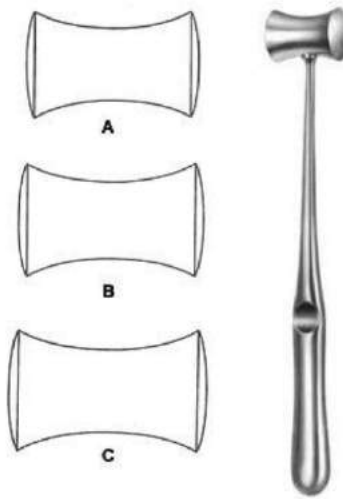

**Williger**

PSI-7-165-01

Mallet

24 cm

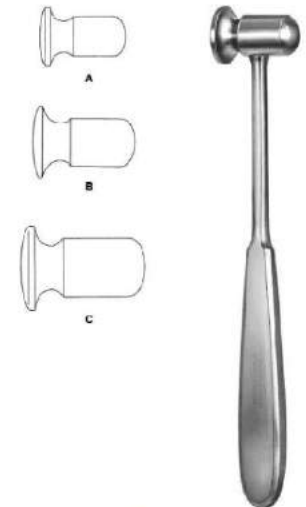

**Doyen**

PSI-7-166-01

Mallet

20.5 cm, 21 cm, 21.5 cm



**Collin**

PSI-7-151-10

Mallet

20 cm

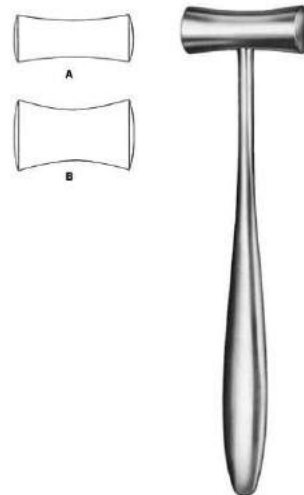

**Lucae**

PSI-7-168-01

Mallet

19.5 cm



**Cottle**

PSI-7-169-19

Mallet

19 cm



**Smith-Petersen**

**PSI-7-158-09**

Gouge

20.5 cm 9mm , 20.5 cm 14mm , 20.5 cm 19mm



**Hoke**

**PSI-7-159-03**

Osteotome

17 cm 3mm , 17 cm 5mm , 17 cm 6mm , 17 cm 8mm

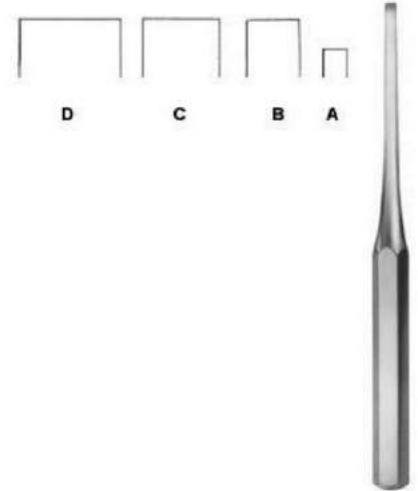

**Hibbs**

**PSI-7-151-10**

Osteotome

24.5 cm 6mm , 24.5 cm 13mm , 24.5 cm 19mm

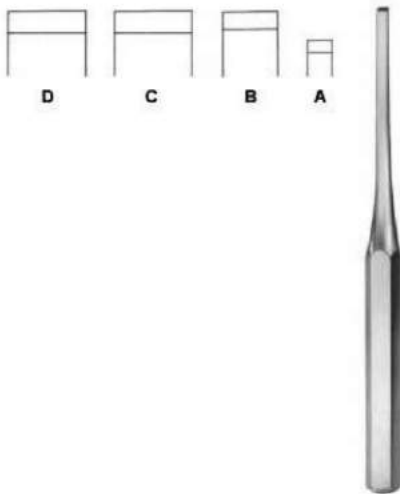

**Hibbs**

**PSI-7-161-06**

Chisel

24.5 cm 6mm , 24.5 cm 13mm , 24.5 cm 19mm

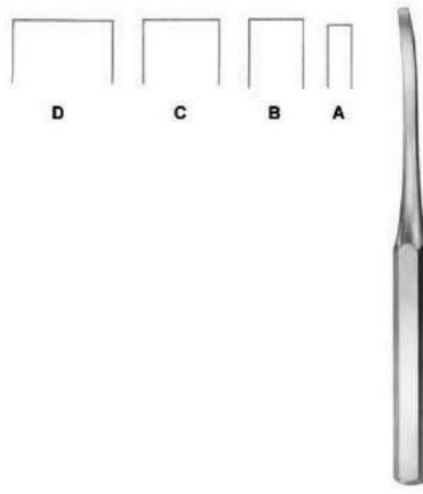

**Hibbs**

**PSI-7-162-06**

Osteotome

24.5 cm 6mm , 24.5 cm 13mm , 24.5 cm 19mm

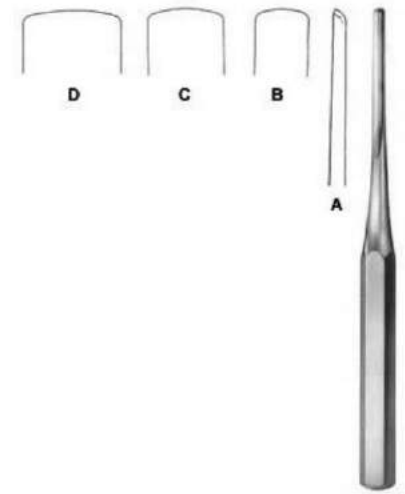

**Hibbs**

**PSI-7-163-06**

Hibbs

24.5 cm 6mm , 24.5 cm 13mm , 24.5 cm 19mm

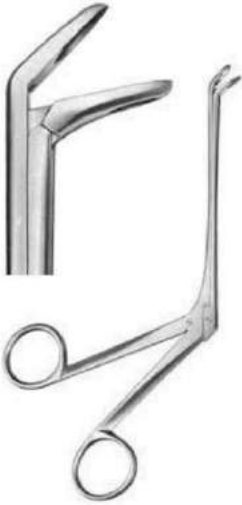

**Weil-Blakesley**

PSI-13-119-01

Ethmoid Bone Forceps shaft length 120mm



**Strycken**

PSI-13-120-01

Nasal Cutting Forceps  
1 - 119x20



**Hartmann**

PSI-13-121-01

Nasal Cutting Forceps  
1 - 119x20



**Schmeden**

PSI-13-122-12

Nasal Cutting Forceps  
1 - 119x20



**Ferris-Smith-Kerrison**

PSI-13-123-17

Sphenoid Bone Punch  
18 cm

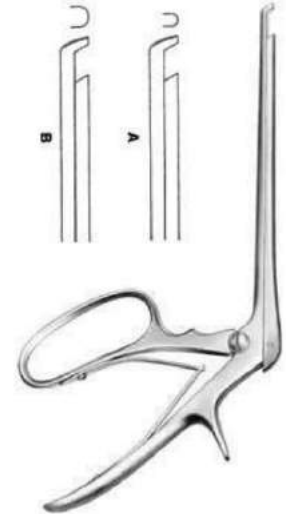

**Ferris-Smith-Kerrison**

PSI-13-124-03

Sphenoid Bone Punch  
18 cm



**Kerrison**

**PSI-13-125-00**

Antrum Punch



**Joseph**

**PSI-13-126-01**

Rhinoplastic Knife

15 cm



**Fomon**

**PSI-13-127-16**

Rhinoplastic Knife

16.5 cm



**Converse**

**PSI-13-128-16**

Rhinoplastic Knife



**Cottle**

**PSI-13-129-15**

Rhinoplastic Knife

14 cm



**Freer**

**PSI-13-130-15**

Mucosa Knife

16.5 cm



**McKenty**

**PSI-13-131-04**

Septum Elevator  
15 cm



**Halle**

**PSI-13-132-16**

Septum Elevator



**Joseph**

**PSI-13-133-16**

Septum Elevator



**Freer**

**PSI-13-134-20**

Septum Elevator  
1 - 119x20

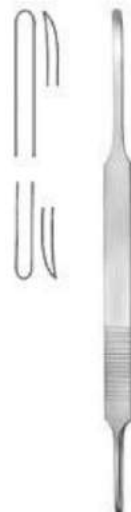

**McKenty**

**PSI-13-135-22**

Septum Elevator  
20.5 cm



**Ballenger-Hajek**

**PSI-13-136-19**

Septum Elevator  
1 - 119x20



**Modell Wien**  
**PSI-13-107-14**  
 Nasal Speculum  
 13.5 cm

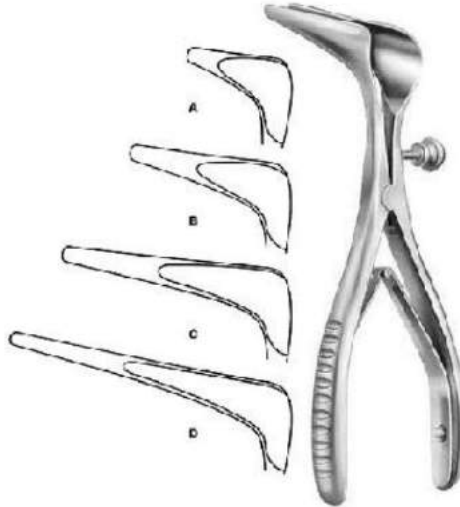

**Cottle**  
**PSI-13-108-35**  
 Nasal Speculum  
 13.5 cm , 14.5 cm



**Cottle**  
**PSI-13-109-45**  
 13.5 cm



**Cottle**  
**PSI-13-110-15**  
 Nasal Tampon Forceps  
 14.5 cm



**Troeltsch**  
**PSI-13-111-18**  
 Nasal Tampon Forceps  
 18 cm



**Grunwald (Jansen)**  
**PSI-13-112-20**  
 Nasal Tampon Forceps



**Cottle**

**PSI-13-137-22**

Septum Elevator  
23 cm

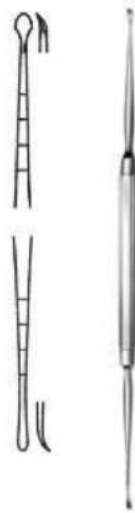

**Masing**

**PSI-13-138-21**

Periosteal Elevator  
1 - 119x20

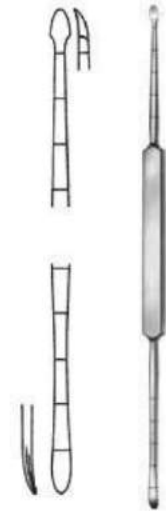

**Cottle**

**PSI-13-139-21**

Periosteal Elevator



**Joseph**

**PSI-13-140-16**

Periosteal Elevator



**Freer**

**PSI-13-141-15**

Septum Gouge  
15 cm



**Killian**

**PSI-13-142-16**

Septum Gouge



**Killian-Claus**  
**PSI-13-143-16**  
 Septum Gouge

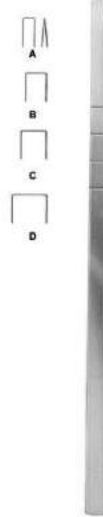

**Cottle**  
**PSI-13-144-04**  
 Osteotome  
 18.5 cm



**Cottle**  
**PSI-13-145-06**  
 Osteotome  
 18.5 cm



**Cottle**  
**PSI-13-146-16**  
 Osteotome  
 18.5 cm



**Walter**  
**PSI-13-147-03**  
 Gouge  
 1 - 119x20



**Fomon**  
**PSI-13-148-04**  
 Chisel

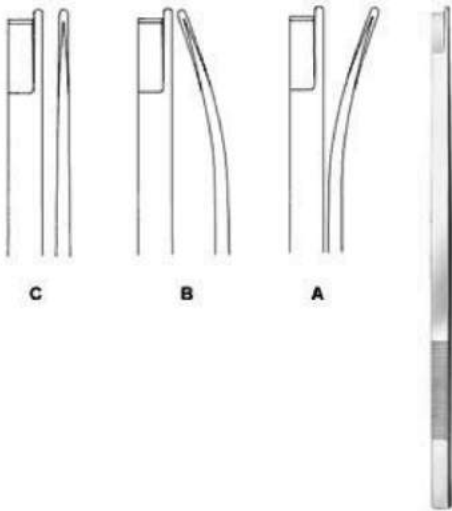

**Neivert-Anderson**

**PSI-13-149-01**

Osteotome  
20.5 cm

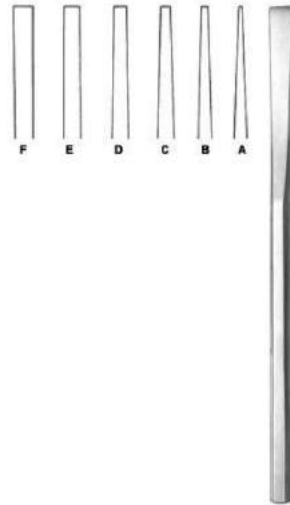

**Sheehan**

**PSI-13-150-01**

Osteotome  
15 cm

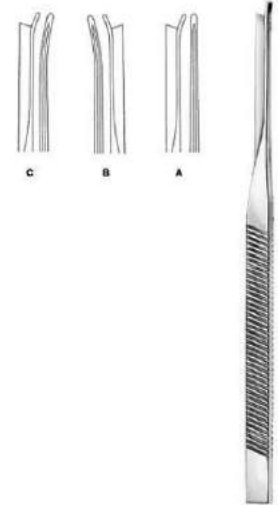

**Silver**

**PSI-13-151-01**

Rhinoplastic Chisel



**Parkes**

**PSI-13-152-01**

Osteotome

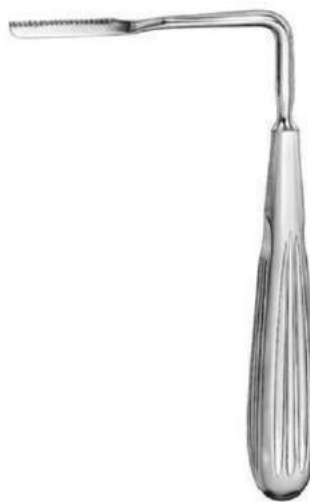

**Joseph**

**PSI-13-153-20**

Nasal Saw  
17 cm

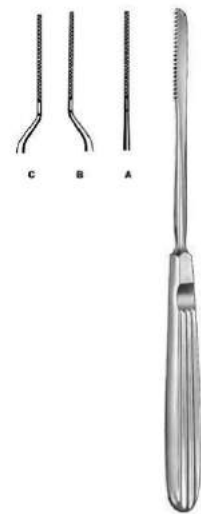

**Joseph**

**PSI-13-154-00**

Nasal Saw  
1 - 119x20



**Maltz**  
**PSI-13-155-18**  
 Nasal Rasp  
 17.5 cm

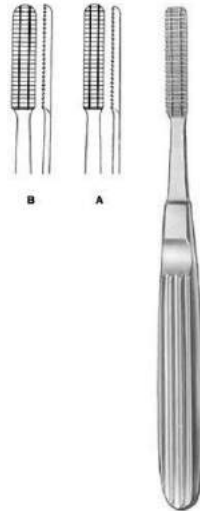

**Maltz**  
**PSI-13-156-01**  
 Nasal Rasp  
 17 cm

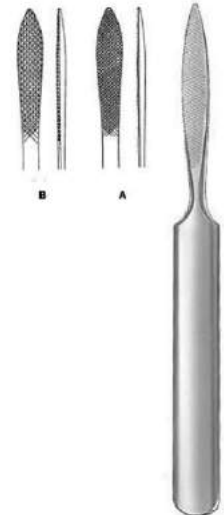

**Joseph**  
**PSI-13-157-01**  
 Bone File



**Cottle**  
**PSI-13-158-21**  
 Nasal Rasp  
 20.5 cm

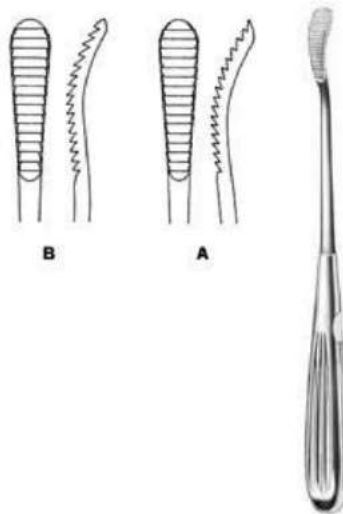

**Aufricht**  
**PSI-13-159-21**  
 Glabella Rasp

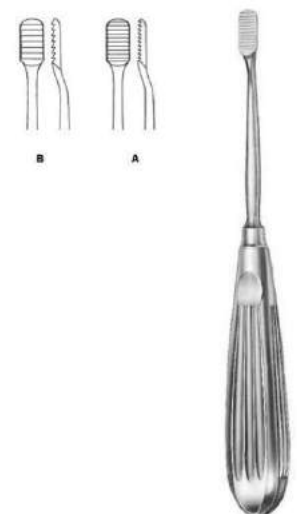

**Lewis**  
**PSI-13-160-18**  
 Nasal Rasp  
 1 - 119x20



**Lewis**  
**PSI-13-161-18**  
 Nasal Rasp  
 1 - 119x20

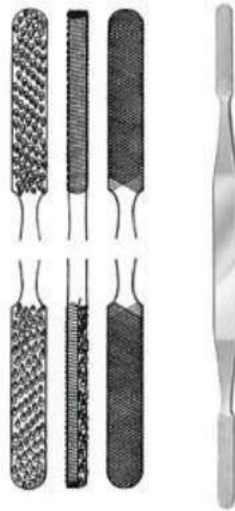

**Fomon**  
**PSI-13-162-01**  
 Bone File  
 20.5 cm



**Cottle**  
**PSI-13-163-01**  
 Nasal Hook  
 17 cm



**Converse**  
**PSI-13-164-01**  
 Nasal Retractor



**Converse**  
**PSI-13-165-12**  
 Alar Hooklet



**Freer**  
**PSI-13-166-15**  
 Mucosa Hooklet  
 15 cm



**Joseph**  
**PSI-13-167-02**  
 Mucosa Hooklet  
 16.5 cm



**Cottle-Neivert**  
**PSI-13-168-20**  
 Alar Hooklet  
 19.5 cm



**Cottle**  
**PSI-13-169-15**  
 Saddle Hook  
 14 cm



**Kressner**  
**PSI-13-170-20**  
 Septum Forceps



**Cottle-Walsham**  
**PSI-13-171-01**  
 Septum Straightening Forceps  
 23 cm



**Asch**  
**PSI-13-172-23**  
 Septum Straightening Forceps  
 22.5 cm



**Ogura**

PSI-13-13-11

Skin Grasping Forceps

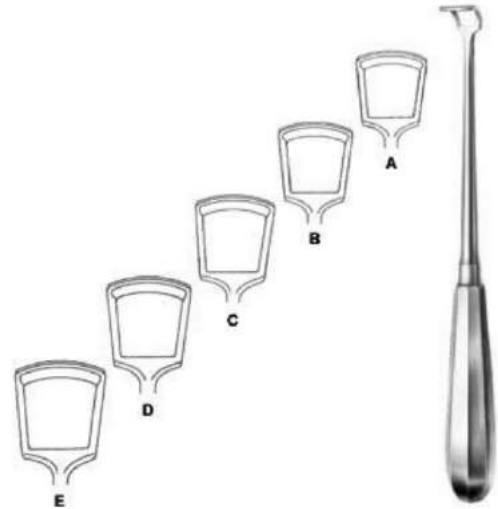

**Beckmann**

PSI-13-174-01

Adenoid Curette  
22.5 cm



**Terry**  
**PSI-14-101-16**  
 Elevator  
 17 cm



**Terry**  
**PSI-14-102-00**  
 Periosteal Elevator

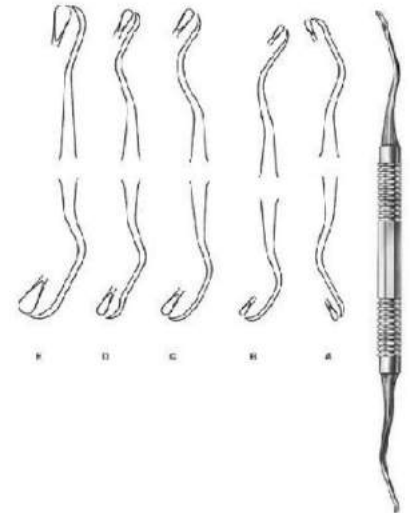

**Sinus Lift Curette**  
**PSI-14-103-01**  
 Sinus Lift Curette  
 17.5 cm, 18.5 cm, 1 - 119x20, 15 cm, 17 cm



**Heister**  
**PSI-14-104-13**  
 Mouth Gag



**Molt**  
**PSI-14-105-11**  
 Mouth Gag



**Denhart**  
**PSI-14-106-12**  
 Mouth Gag

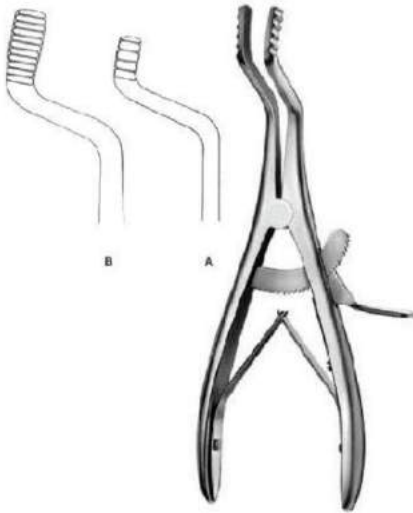

**Roser-Konig**

PSI-14-107-16

Mouth Gag

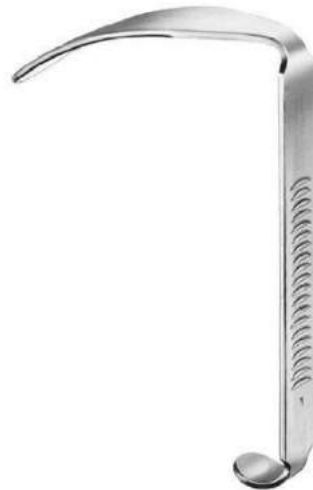

**Roser-Knig**

PSI-14-108-16

Mouth Gag  
13.5 cm



**Jennings**

PSI-14-109-09

Mouth Gag  
10.5 cm



**Oringer**

PSI-14-110-00

Lip and Cheek Retractor  
10.5 cm , 10



**Martin-Simplex**

PSI-14-111-11

Cheek Retractor  
10.5 cm



**Vestibulum Retractor**

PSI-14-112-14

Vestibulum Retractor  
14 cm



**Sternberg**

PSI-14-113-14

Lip and Cheek Retractor  
14 cm



**Obwegeser**

PSI-14-114-12

Cheek Retractor  
12 cm



**Cawood-Minnesota**

PSI-14-115-15

Cheek Retractor  
15 cm

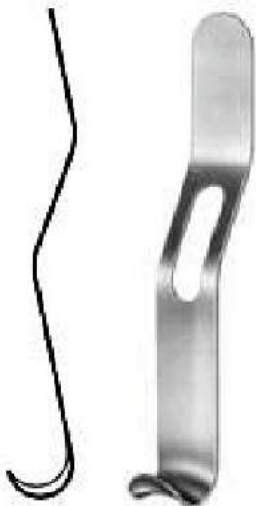

**Cheek Retractor**

PSI-14-116-00

Cheek Retractor  
14 cm



**Hartmann**

PSI-14-117-15

Tongue Depressor  
15 cm



**Tobold**

PSI-14-118-14

Tongue Depressor  
15 cm



**Tobold**

**PSI-14-119-14**

Tongue Depressor  
14.5 cm



**Tongue Spatula**

**PSI-14-120-16**

Tongue Spatula



**Tongue Spatula**

**PSI-14-121-15**

Tongue Spatula  
15 cm



**Martin**

**PSI-14-122-18**

Tongue Spatula  
18.5 cm



**Doyen**

**PSI-14-123-18**

Tongue Spatula  
13.5 cm



**Bruennings**

**PSI-14-124-19**

Tongue Spatula  
1 - 119x20



**Collin**

PSI-14-125-17

Tongue Holding Forceps  
17 cm



**Young**

PSI-14-126-17

Tongue Holding Forceps  
15 cm



**Obwegeser**

PSI-14-127-40

Soft Tissue Retractor



**Obwegeser**

PSI-14-128-22

Nasal Spine Retractor



**Obwegeser**

PSI-14-129-22

Ramus Retractor



**Obwegeser**

PSI-14-130-16

Chin Retractor  
16.5 cm



**Obwegeser**

**PSI-14-131-18**

Channel Retractor  
17 cm



**Retractor**

**PSI-14-132-01**

Retractor  
18.5 cm



**Periosteal Elevator**

**PSI-14-133-01**

Periosteal Elevator



**Obwegeser**

**PSI-14-134-06**

Periosteal Elevator  
17.5 cm



**Obwegeser**

**PSI-14-135-21**

Elevator  
20.5 cm



**Gillies**

**PSI-14-136-21**

Zygoma Elevator



**Keen**

**PSI-14-143-01**

Bone Holding Forceps  
17.5 cm



**Steinhauser**

**PSI-14-144-01**

Bone Holding Forceps



**Wolford**

**PSI-14-145-25**

Bone Holding Forceps  
25 cm



**Salyer**

**PSI-14-146-16**

Bone Holding Forceps



**Bauer**

**PSI-14-147-00**

Osteotome  
20.5 cm



**Bauer**

**PSI-14-148-00**

Osteotome  
20.5 cm



**Epker-Bauer**

PSI-14-149-01

Osteotome  
17.5 cm



**Dautrey-Munro**

PSI-14-150-04

Osteotome



**Dunn-Dautrey**

PSI-14-151-04

Osteotome  
16.5 cm



**Dunn-Dautrey**

PSI-14-152-01

Osteotome  
17 cm



**Epker**

PSI-14-153-04

Osteotome



**Hargis**

PSI-14-154-19

Anterior Border Stripper  
1 - 119x20



# MADNI IMPEX

*SURGICAL INSTRUMENTS SUPPLIERS*

We are surgical instruments manufactures and whole sales dealer & supplier  
For good quality and good price Invite us for Quotation our best price for You.

**[MADNI-IMPEX.COM](http://MADNI-IMPEX.COM)**



**Call Now.**  
**0524264924**





**Epker-Bauer**

PSI-14-149-01

Osteotome  
17.5 cm



**Dautrey-Munro**

PSI-14-150-04

Osteotome



**Dunn-Dautrey**

PSI-14-151-04

Osteotome  
16.5 cm



**Dunn-Dautrey**

PSI-14-152-01

Osteotome  
17 cm



**Epker**

PSI-14-153-04

Osteotome



**Hargis**

PSI-14-154-19

Anterior Border Stripper  
1 - 119x20



**Hargis**

**PSI-14-155-01**

Periosteal Elevator  
23 cm



**Hargis**

**PSI-14-156-18**

Periform Rim Retractor  
18.5 cm



**Hargis**

**PSI-14-157-22**

Pterygoid Osteotome



**Smith**

**PSI-14-158-01**

Sagittal Split Separator  
17 cm



**Terry**

**PSI-14-159-16**

Mandibular Retractor  
16.5 cm



**Terry**

**PSI-14-160-24**

Ramus Pusher  
24 cm



**Obwegeser**

**PSI-14-131-18**

Channel Retractor  
17 cm



**Retractor**

**PSI-14-132-01**

Retractor  
18.5 cm



**Periosteal Elevator**

**PSI-14-133-01**

Periosteal Elevator



**Obwegeser**

**PSI-14-134-06**

Periosteal Elevator  
17.5 cm



**Obwegeser**

**PSI-14-135-21**

Elevator  
20.5 cm



**Gillies**

**PSI-14-136-21**

Zygoma Elevator



**Terry**  
**PSI-14-161-00**  
Occlusal Wedge



**Steinhaus**  
**PSI-14-162-18**  
Elevator  
18.5 cm



**Steinhäuser**  
**PSI-14-163-07**  
Ramus Osteotome  
17 cm



**Steinhaus**  
**PSI-14-164-07**  
Chisel  
1 - 119x20



**Steinhaus**  
**PSI-14-165-01**  
Periosteal Elevator



**Steinhäuser**  
**PSI-14-166-16**  
Steinhäuser  
16.5 cm



**Steinhilber**

**PSI-14-167-05**

Orbital Osteotome



**Wolford**

**PSI-14-168-06**

Osteotome  
23 cm



**Salyer**

**PSI-15-101-18**

Cleft Palate Hooklet  
18.5 cm



**Salyer**

**PSI-15-102-18**

Cleft Palate Hooklet  
18.5 cm



**Salyer**

**PSI-15-103-08**

Cleft Palate Dissector  
18.5 cm



**Salyer**

**PSI-15-104-18**

Cleft Palate Dissector



**Salyer**

**PSI-15-105-18**

Cleft Palate Elevator



**Salyer**

**PSI-15-106-18**

Cleft Palate Elevator



**Salyer**

PSI-15-107-18

Cleft Palate Elevator



**JABOMA**

PSI-15-108-17

Cleft Palate Periosteal Elevator  
17 cm



**Hurd**

PSI-15-109-21

Cleft Palate Needle  
20.5 cm



**Hurd**

PSI-15-111-21

Cleft Palate Needle  
20.5 cm

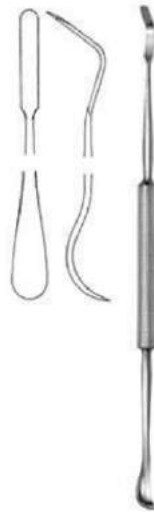

**Carpenter**

PSI-15-112-25

Tonsil Knife / Enucleator  
25 cm



**Hurd**

PSI-15-113-22

Tonsil Dissector/Retractor  
22.5 cm

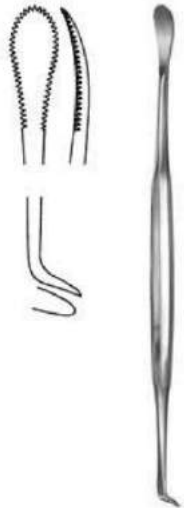

**Henke**  
PSI-15-114-23  
Tonsil Elevator  
22.5 cm



**Henke**  
PSI-15-115-23  
Tonsil Elevator  
22.5 cm



**Luniatschek**  
PSI-15-116-19  
Gauze Packer  
17.5 cm



**Luniatschek**  
PSI-15-116-19  
Gauze Packer  
17.5 cm



**White**  
PSI-15-118-18  
Tonsil Grasping Forceps



**Blohmke**  
PSI-15-119-20  
Tonsil Grasping Forceps

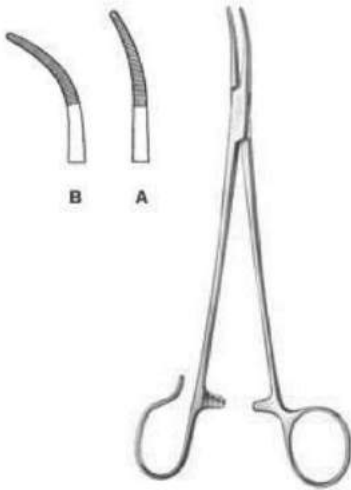

**Schnidt**  
**PSI-15-120-19**  
 Tonsil Forceps  
 1 - 119x20

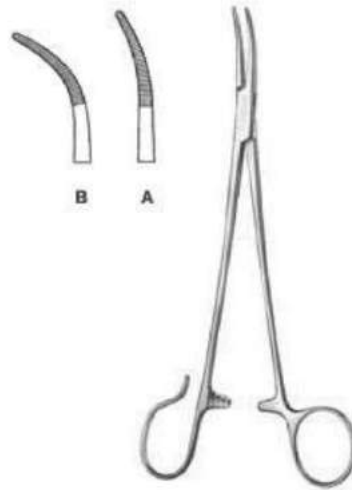

**Schnidt**  
**PSI-15-121-19**  
 Tonsil Forceps  
 1 - 119x20, 18.5 cm



**Eves**  
**PSI-15-122-28**  
 Tonsil Snare



**Eves**  
**PSI-15-123-28**  
 Tonsil Snare



**Brunings**  
**PSI-15-124-28**  
 Tonsil Snare

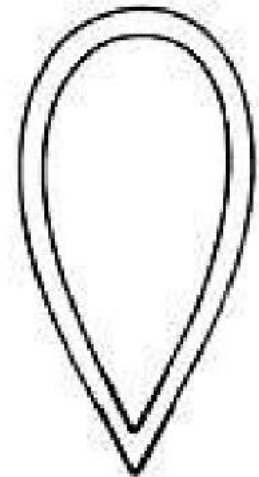

**Wire Loop**  
**PSI-15-125-40**



**Snare Wire**  
PSI-15-126-01

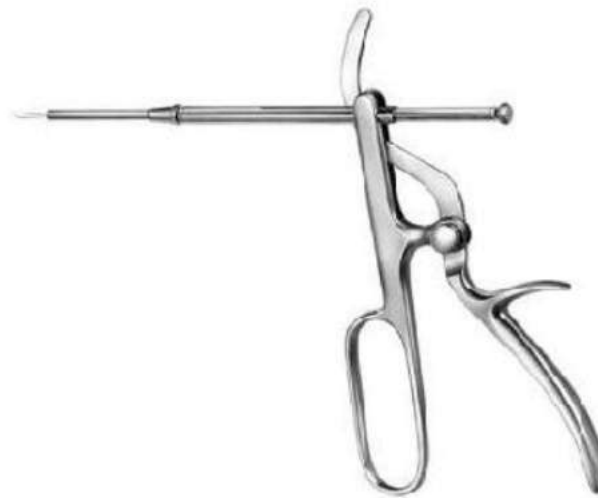

**Tyding**  
PSI-15-127-01  
Tonsil Snare



**Hartmann**  
PSI-15-128-13  
Tonsil Punch  
12 cm



**Huber**  
PSI-15-129-01  
Universal Handle  
30 cm



**Bruenings**  
PSI-15-130-20  
Interchangeable Tube



**Bruenings**  
PSI-15-131-20  
Laryngeal Tube