



DOOOWAY

SANITARY WARE



ABOUT US

Dooway Sanitary ware factory was founded in 2001. By more than ten year's experiences, It has expanded to quite scale and professional ceramics sanitary ware manufacturing enterprise with modern production area of nearby 10,000 square meters. 500,000pcs products around can be produced by advanced equipments every year owning a grate deal of first class managing personnel high quality marketing teams.

Quality is the first and continuously innovate. We have gotten CE, CUPC, Watermark certificate. Almost of the goods are exported to the foreign customers. Such as Germany, Italy, UK, Russia, U.S. A., Canada and Australia, we also ship to the Middle East country.

We would like to invite you to visit our company. You will be welcome in our company.

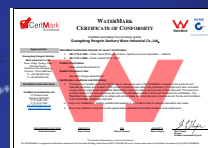

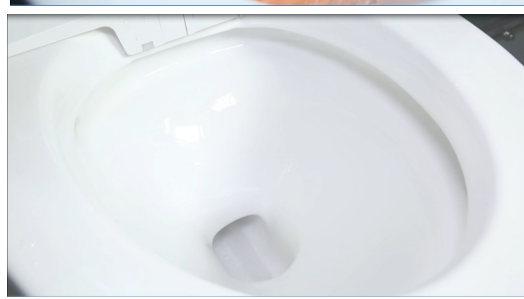
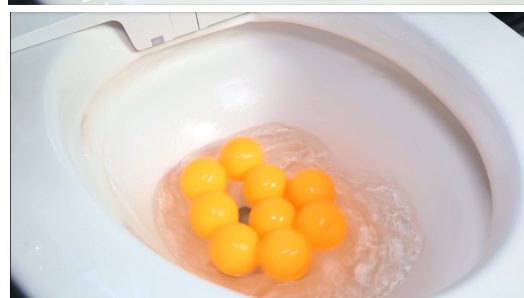
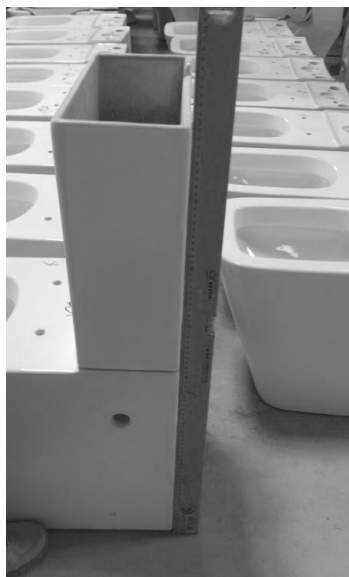

EXPERT 专业

产品二检

APPEARANCE& DEFORMATION INSPECTION

外观,釉面,变形检验

1. 外观检验

Appearance inspection

根据产品外观质量标准进行产品分级检验

Classify inspection according to the standard of appearance checking

2. 变形检验

Deformation inspection

根据标准对产品平直度、平衡度、水平度的进行检验

Inspecting by flatness, balance degree and levelness

FUNCTION INSPECTION

各项性能检验

3. 漏水检验;

Leakage inspection

在单位压力下对座便器底部和存水弯进行漏水检验。

Under the unit stress, inspect the bottom of toilet and trap

4. 冲水性能检验

Flushing function inspection

用标准在单位时间内对座便器进行物体通过检验

Inspection of passing object though toilet in standard unit time

5. 复检检测外观,尺寸和规格

Re-inspection appearance, dimension and fix specification

(Before Loading)

6. 抽检漏水和冲洗功能

Re-inspection Leak test& Flushing function inspection

PACKING INSPECTION

包装检验

套间系列
Suite Series



DT2040
直冲分体坐便器
Washdown Close-couched Closet
Size:650x370x785mm
S-trap,250mm Roughing-in
地排污口中心离墙250mm
P-trap,180mm Roughing-in
横排污口中心离地180mm

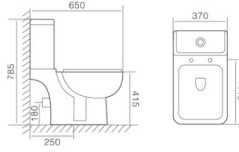

DT8040H
直冲分体坐便器
Washdown Close-couched Closet
Size:670x370x880mm
S-trap,220,250mm Roughing-in
地排污口中心离墙220,250mm
P-trap,180mm Roughing-in
横排污口中心离地180mm



DF040
妇洗器
Bidet
Size:560x355x405mm
Fixing to wall with back
背靠墙式安装

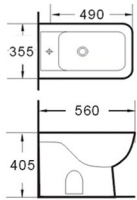

DW240
立柱盆
Pedestal Basin
Size:610x475x840mm
Fixing to wall with back
背靠墙式安装

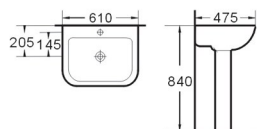



DT2080

直冲分体坐便器
Washdown Close-couched Closet
Size:700x380x790mm
S-trap,250mm Roughing-in
地排污口中心离墙250mm
P-trap,180mm Roughing-in
横排污口中心离地180mm

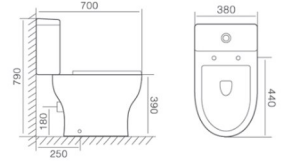

DF080

妇洗器
Bidet
Size:540x370x390 mm
Fixing to wall with back
背靠墙式安装

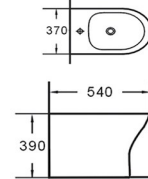

DW280G

挂盆
Wall-hung Basin
Size:550x470x490mm
Fixing to wall with back
背靠墙式安装

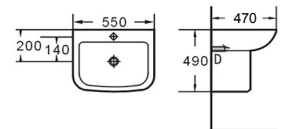

DW280

立柱盆
Pedestal Basin
Size:550x470x870mm
Fixing to wall with back
背靠墙式安装

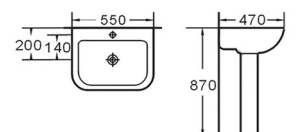



DT2044
直冲分体坐便器
Washdown Close-couched Closet
Size:710x390x765mm
S-trap,250mm Roughing-in
地排污口中心离墙250mm
P-trap,180mm Roughing-in
横排污口中心离地180mm

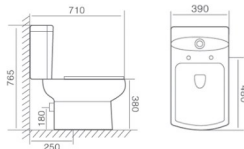

DT2004
直冲分体坐便器
Washdown Close-couched Closet
Size:685x405x790mm
S-trap,250,300mm Roughing-in
地排污口中心离墙250,300mm
P-trap,180mm Roughing-in
横排污口中心离地180mm

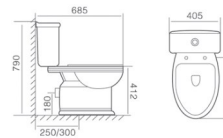

DW344
立柱盆
Pedestal Basin
Size:580x460x850mm
Fixing to wall with back
背靠墙式安装

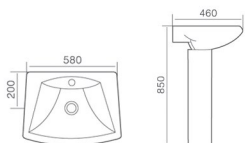

DW204
立柱盆
Pedestal Basin
Size:580x440x830mm
Fixing to wall with back
背靠墙式安装

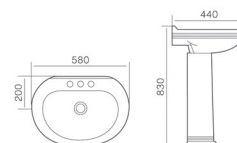

DF044
妇洗器
Bidet
Size:595x400x425mm
Fixing to wall with back
背靠墙式安装



DF004
妇洗器
Bidet
Size:565x362x390mm
Fixing to wall with back
背靠墙式安装



DT2020
直冲分体坐便器
Washdown Close-couched Closet
Size:700x380x740mm
S-trap,250,300mm Roughing-in
地排污口中心离墙250,300mm
P-trap,180mm Roughing-in
横排污口中心离地180mm

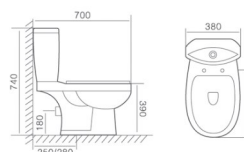

DW212
立柱盆
Pedestal Basin
Size:520x445x800mm
Fixing to wall with back
背靠墙式安装

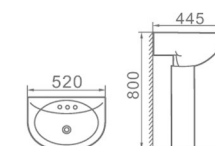



DG115
直冲式挂墙坐便器
Washdown Wall-hung Toilet
Size:560x350x340mm
P-trap,180mm Roughing-in
横排污口中心离地180mm

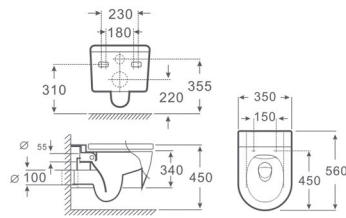

DW007
挂盆
Wall-hung Basin
Size:525x440x385mm
Fixing to wall with back
背靠墙式安装

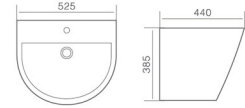

DG133
直冲式挂墙坐便器
Washdown Wall-hung Toilet
Size:560x360x310mm
P-trap,180mm Roughing-in
横排污口中心离地180mm

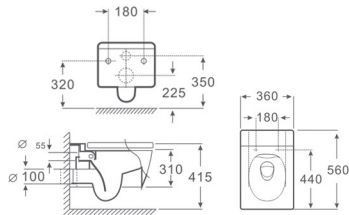

DW001
挂盆
Wall-hung Basin
Size:520x440x385mm
Fixing to wall with back
背靠墙式安装

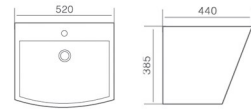

DG151-F
直冲式落地坐便器
Washdown Close-couched Toilet
Size:590x350x410mm
P-trap,180mm Roughing-in
横排污口中心离地180mm

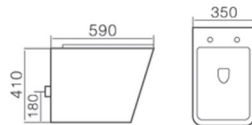

DF051
妇洗器
Bidet
Size:567x350x400mm
Fixing to wall with back
背靠墙式安装



DT2205
直冲分体坐便器
Washdown Close-couched Closet
Size:750x520x1030mm
P-trap,180mm Roughing-in
横排污口中心离地180mm

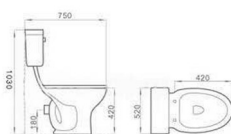

DT2206
直冲分体坐便器
Washdown Close-couched Closet
Size:680x380x880mm
P-trap,180mm Roughing-in
横排污口中心离地180mm

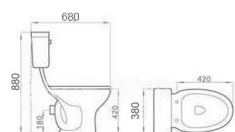



DT2051
直冲分体坐便器
WaterMark
Washdown Close-couched Closet
Size:690x355x835mm
P-trap,180mm Roughing-in
横排污口中心离地180mm

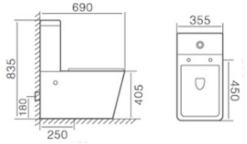

DT2057
直冲分体坐便器
WaterMark
Washdown Close-couched Closet
Size:690x370x850mm
P-trap,180mm Roughing-in
横排污口中心离地180mm

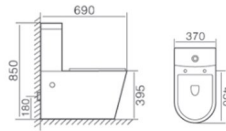

DT2062
直冲分体坐便器
WaterMark
Washdown Close-couched Closet
Size:690x390x830mm
P-trap,180mm Roughing-in
横排污口中心离地180mm

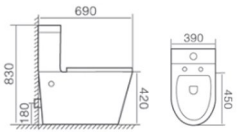

DT2512
直冲分体坐便器
WaterMark
Washdown Close-couched Closet
Size:640x360x800mm
P-trap,180mm Roughing-in
横排污口中心离地180mm

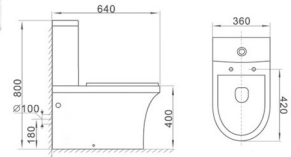

DT2602
虹吸分体坐便器
UPC
WaterSense
Siphonic Close-couched Closet
Size:710x370x765mm
S-trap,305mm Roughing-in
地排污口中心离墙305mm

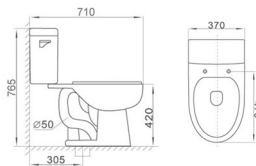

DT2604
虹吸分体坐便器
UPC
WaterSense
Siphonic Close-couched Closet
Size:720x400x820mm
S-trap,305mm Roughing-in
地排污口中心离墙305mm

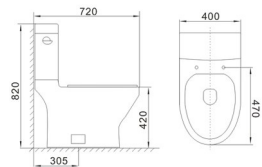

DA8151
虹吸连体坐便器
UPC
Siphonic One-piece Toilet
Size:735x390x750mm
S-trap,300,400mm Roughing-in
地排污口中心离墙300,400mm

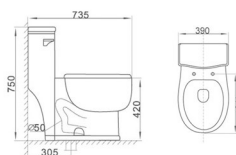

DA8324
虹吸连体坐便器
UPC
Siphonic One-piece Toilet
Size:685x380x705mm
S-trap,300,400mm Roughing-in
地排污口中心离墙300,400mm

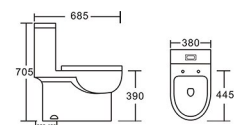



Rimless



Rimless

DA8063

直冲连体坐便器
Washdown One-piece Closet
Size: 680x350x800mm
S-trap, 250mm Roughing-in
地排污口中心离墙250mm
P-trap, 180mm Roughing-in
横排污口中心离地180mm

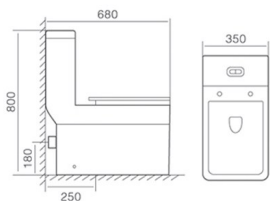

Rimless

DT2063

直冲连体坐便器
Washdown Close-couthed Closet
Size: 680x350x850mm
P-trap, 180mm Roughing-in
横排污口中心离地180mm

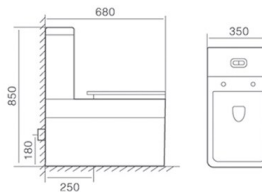

Rimless

DG163

挂墙式坐便器
Washdown Wall-hung Closet
Size: 585x350x330 mm
P-trap, 180mm Roughing-in
横排污口中心离地180mm

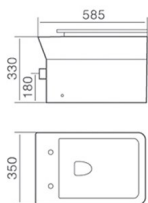

DF063

妇洗器
Bidet
Size: 585x350x410 mm
Fixing to wall with back
背靠墙式安装

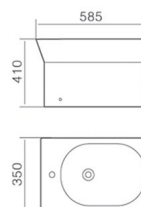



DA8001
虹吸/直冲连体坐便器
Siphonic/Washdown One-piece Toilet
Size:750x390x775mm
S-trap,250,300,400mm Roughing-in
地排污口中心离墙250,300,400mm
P-trap,180mm Roughing-in
横排污口中心离地180mm

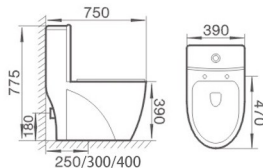

DA8007
虹吸/直冲连体坐便器
Siphonic/Washdown One-piece Toilet
Size:685x380x820mm
S-trap,250,300,400mm Roughing-in
地排污口中心离墙250,300,400mm
P-trap,180mm Roughing-in
横排污口中心离地180mm

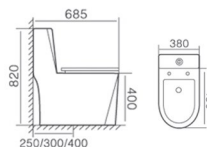

DA8008
虹吸连体坐便器
Siphonic One-piece Toilet
Size:740x390x680mm
S-trap,305mm Roughing-in
地排污口中心离墙305mm

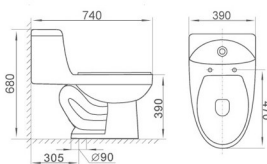

DA8015
虹吸连体坐便器
Siphonic One-piece Toilet
Size:660x420x590mm
S-trap,250,305mm Roughing-in
地排污口中心离墙250,305mm

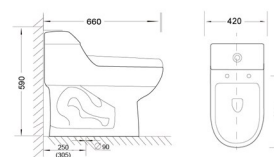

DA8018
直冲连体坐便器
Washdown One-piece Toilet
Size:710x365x650mm
S-trap,250,300mm Roughing-in
地排污口中心离墙250,300mm
P-trap,180mm Roughing-in
横排污口中心离地180mm

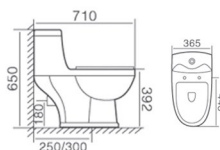

DA8030
直冲连体坐便器
Washdown One-piece Toilet
Size:700x360x810mm
S-trap,250mm Roughing-in
地排污口中心离墙250mm
P-trap,180mm Roughing-in
横排污口中心离地180mm

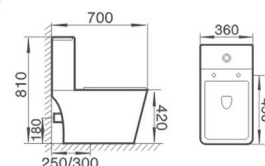

DA8061
虹吸/直冲连体坐便器
Siphonic/Washdown One-piece Toilet
Size:705x370x790mm
S-trap,250,300,400mm Roughing-in
地排污口中心离墙250,300,400mm
P-trap,180mm Roughing-in
横排污口中心离地180mm

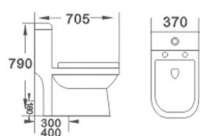

DA8069
直冲连体坐便器
Washdown One-piece Toilet
Size:720x420x700mm
S-trap,250,300mm Roughing-in
地排污口中心离墙250,300mm
P-trap,180mm Roughing-in
横排污口中心离地180mm

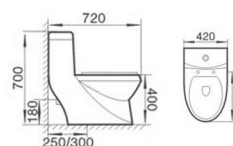



DA8070
虹吸/直冲连体坐便器
Siphonic/Washdown One-piece Toilet
Size: 690x370x750mm
S-trap, 250, 300, 400mm Roughing-in
地排污口中心离墙250, 300, 400mm
P-trap, 180mm Roughing-in
横排污口中心离地180mm

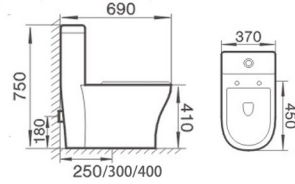

DA8071
虹吸连体坐便器
Siphonic One-piece Toilet
Size: 650x345x745mm
S-trap, 300, 400mm Roughing-in
地排污口中心离墙300, 400mm

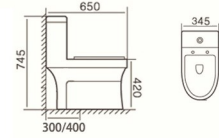

DA8073
虹吸/直冲连体坐便器
Siphonic/Washdown One-piece Toilet
Size: 720x380x830mm
S-trap, 250, 300, 400mm Roughing-in
地排污口中心离墙250, 300, 400mm
P-trap, 180mm Roughing-in
横排污口中心离地180mm

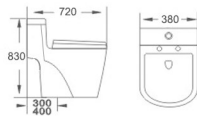

DA8075
虹吸/直冲连体坐便器
Siphonic/Washdown One-piece Toilet
Size: 725x400x650mm
S-trap, 250, 300, 400mm Roughing-in
地排污口中心离墙250, 300, 400mm
P-trap, 180mm Roughing-in
横排污口中心离地180mm

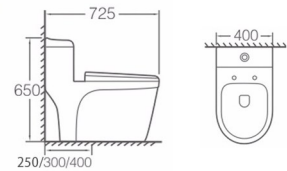

DA8088
虹吸连体坐便器
Siphonic One-piece Toilet
Size: 730x450x645mm
S-trap, 300mm Roughing-in
地排污口中心离墙300mm

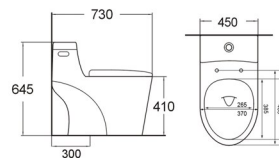

DA8089
虹吸连体坐便器
Siphonic One-piece Toilet
Size: 740x450x600mm
S-trap, 300, 400mm Roughing-in
地排污口中心离墙300, 400mm

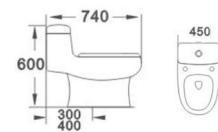

DA8090
虹吸连体坐便器
Siphonic One-piece Toilet
Size: 745x455x655mm
S-trap, 305, 400mm Roughing-in
地排污口中心离墙305, 400mm

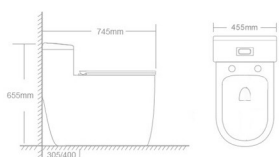

DA8111
虹吸/直冲连体坐便器
Siphonic/Washdown One-piece Toilet
Size: 730x365x780mm
S-trap, 250, 300, 400mm Roughing-in
地排污口中心离墙250, 300, 400mm
P-trap, 180mm Roughing-in
横排污口中心离地180mm

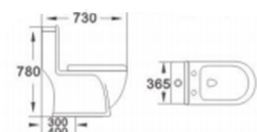



DA8114
直冲连体坐便器
Washdown One-piece Toilet
Size:700x370x750mm
S-trap,250mm Roughing-in
地排污口中心离墙250mm
P-trap,180mm Roughing-in
横排污口中心离地180mm

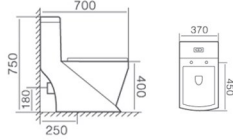

DA8119
虹吸连体坐便器
Siphonic One-piece Toilet
Size:665x360x705mm
S-trap,300,400mm Roughing-in
地排污口中心离墙300,400mm

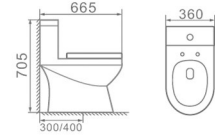

DA8302
虹吸连体坐便器
Siphonic One-piece Toilet
Size:700x385x780mm
S-trap,300,400mm Roughing-in
地排污口中心离墙300,400mm

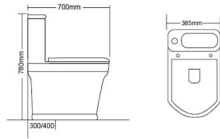

DA8304
虹吸/直冲连体坐便器
Siphonic/Washdown One-piece Toilet
Size:720x370x775mm
S-trap,250,300,400mm Roughing-in
地排污口中心离墙250,300,400mm
P-trap,180mm Roughing-in
横排污口中心离地180mm

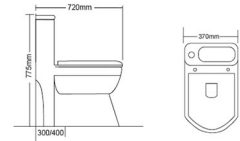

DP001
蹲便器
Squatting Pan W.C.
Size:550x450x200mm
Build-in platform

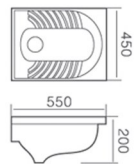

DP003
蹲便器
Squatting Pan W.C.
Size:515x420x205mm
Build-in platform

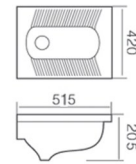

DP005
蹲便器
Squatting Pan W.C.
Size:540x430x200mm
Build-in platform

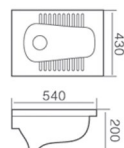

DP006-S
蹲便器
Squatting Pan W.C.
Size:590x460x280mm
Build-in platform

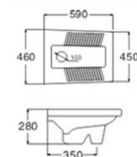



DG111
直冲式挂墙坐便器
Washdown Wall-hung Toilet
Size: 570x380x340mm
P-trap, 180mm Roughing-in
横排污口中心离地180mm

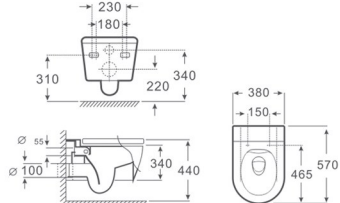

DG113
直冲式挂墙坐便器
Washdown Wall-hung Toilet
Size: 595x380x330mm
P-trap, 180mm Roughing-in
横排污口中心离地180mm

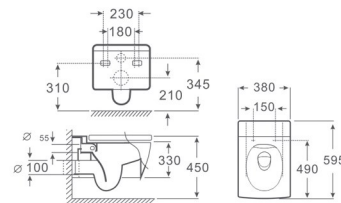

对冲
超漩
DG162
直冲式/对冲式/超漩式挂墙坐便器
Washdown/Collision type flush/
Eddy double hole Wall-hung Toilet
Size: 520x360x310mm
P-trap, 180mm Roughing-in
横排污口中心离地180mm

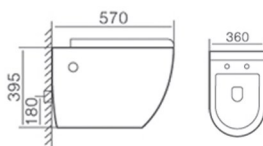

DG143
直冲式挂墙坐便器
Washdown Wall-hung Toilet
Size: 590x340x405mm
P-trap, 180mm Roughing-in
横排污口中心离地180mm

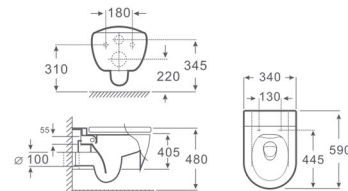

DG167
直冲式挂墙坐便器
Washdown Wall-hung Toilet
Size: 510x360x375mm
P-trap, 180mm Roughing-in
横排污口中心离地180mm

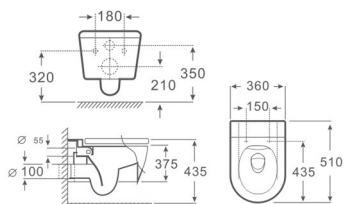

超漩
DG177
超漩式挂墙坐便器
Eddy double hole Wall-hung Toilet
Size: 530x360x310mm
P-trap, 180mm Roughing-in
横排污口中心离地180mm

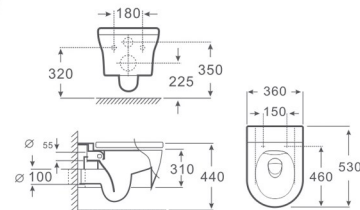

立柱盆系列
Pedestal Basin Series



DW202
立柱盆
Pedestal Basin
Size: 510x415x760mm
Fixing to wall with back
背靠墙式安装

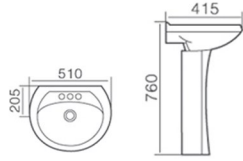

DW207
立柱盆
Pedestal Basin
Size: 490x410x850mm
Fixing to wall with back
背靠墙式安装

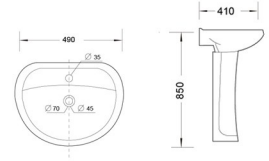

DW218
立柱盆
Pedestal Basin
Size: 620x460x800mm
Fixing to wall with back
背靠墙式安装

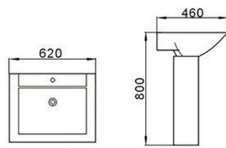

DW219
立柱盆
Pedestal Basin
Size: 650x510x860mm
Fixing to wall with back
背靠墙式安装

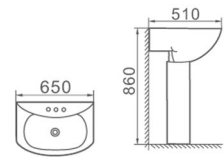

DW317
立柱盆
Pedestal Basin
Size: 545x435x840mm
Fixing to wall with back
背靠墙式安装

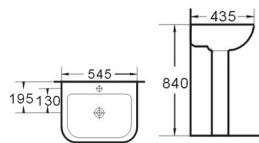

DW240G
挂盆
Wall-hung Basin
Size: 610x475x450mm
Fixing to wall with back
背靠墙式安装

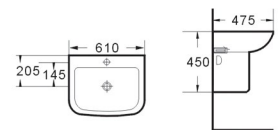

DW216
挂盆
Wall-hung Basin
Size: 460x420x190mm
Fixing to wall with back
背靠墙式安装

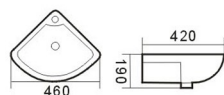

DW217
挂盆
Wall-hung Basin
Size: 415x375x180mm
Fixing to wall with back
背靠墙式安装



DW535

挂盆
Wall-hung Basin
Size:455x510x400mm
Fixing to wall with back
背靠墙式安装

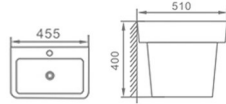

DW536

挂盆
Wall-hung Basin
Size:465x560x365mm
Fixing to wall with back
背靠墙式安装

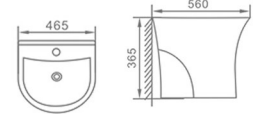

DW537

挂盆
Wall-hung Basin
Size:445x525x360mm
Fixing to wall with back
背靠墙式安装

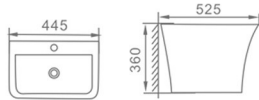

DW539

挂盆
Wall-hung Basin
Size:460x475x360mm
Fixing to wall with back
背靠墙式安装

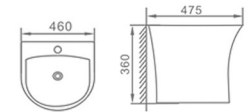

DL001

连体立柱盆
Pedestal Basin
Size:550x515x850mm
Fixing to wall with back
背靠墙式安装

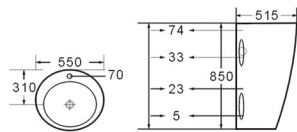

DL006

连体立柱盆
Pedestal Basin
Size:460x460x820mm
Fixing to wall with back
背靠墙式安装

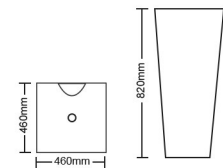

DL013

连体立柱盆
Pedestal Basin
Size:280x310x870mm
Fixing to wall with back
背靠墙式安装

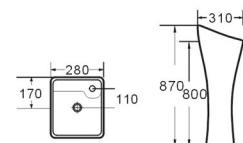

DL020

连体立柱盆
Pedestal Basin
Size:510x510x865mm
Fixing to wall with back
背靠墙式安装

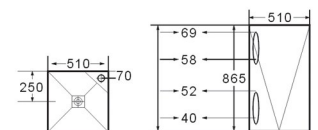

► DL003A



立柱盆
尺寸: 460x460x850mm
背靠墙安装
Pedestal basin
Size: 460x460x850mm
Fixing to wall with back

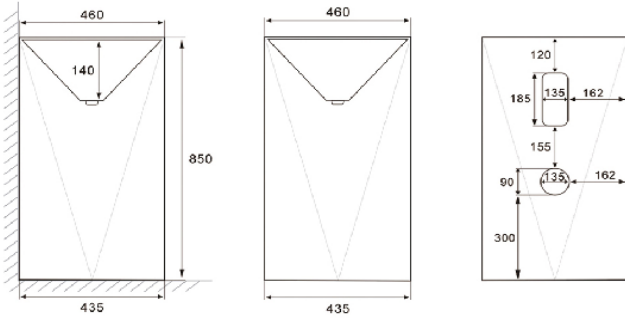
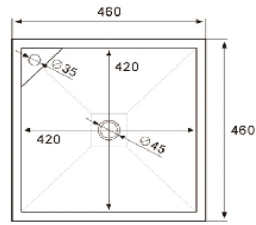

► DL003B



立柱盆
尺寸: 460x460x850mm
背靠墙安装
Pedestal basin
Size: 460x460x850mm
Fixing to wall with back

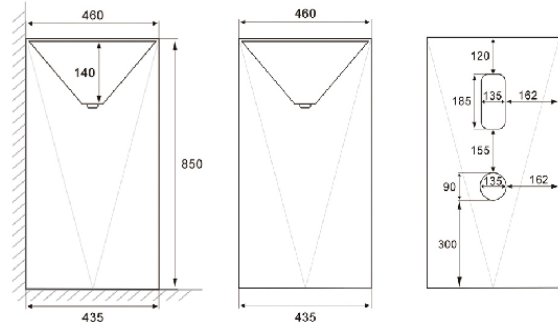
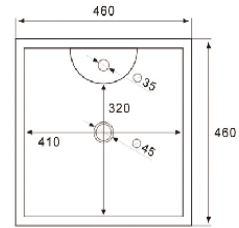

► DL003C



立柱盆
尺寸: 460x460x850mm
背靠墙安装
Pedestal basin
Size: 460x460x850mm
Fixing to wall with back

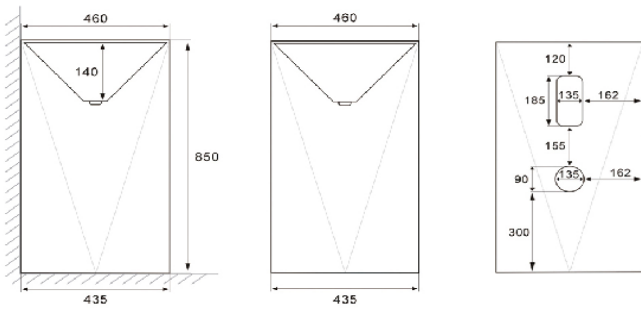
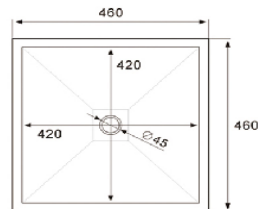

艺术盆系列
Art Basin Series



DW1002/1002A

艺术盆
Art Basin
Size:465x465x155mm
Size:410x410x145mm
Above counter mounting
台面上安装

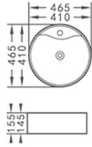

DW1007

艺术盆
Art Basin
Size:545x445x170mm
Above counter mounting
台面上安装

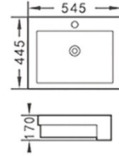

DW1008A

艺术盆
Art Basin
Size:570x450x160mm
Above counter mounting
台面上安装

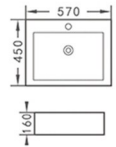

DW1017

艺术盆
Art Basin
Size:420x420x170mm
Above counter mounting
台面上安装

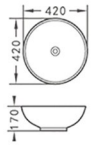

DW1025

艺术盆
Art Basin
Size:490x375x135mm
Above counter mounting
台面上安装

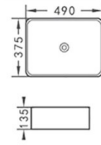

DW1079/1079A/1079B

艺术盆
Art Basin
Size:460x460x160mm
Size:420x420x155mm
Size:385x385x130mm
Above counter mounting
台面上安装

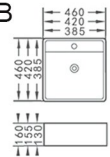

DW1233/1233A

艺术盆
Art Basin
Size:670x440x150mm
Size:590x395x140mm
Above counter mounting
台面上安装

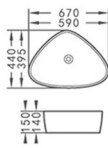

DW1269

艺术盆
Art Basin
Size:585x460x150mm
Above counter mounting
台面上安装

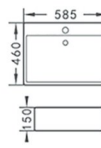

DW1427

艺术盆
Art Basin
Size:515x400x135mm
Above counter mounting
台面上安装

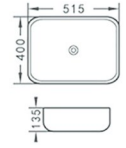

DW1430

艺术盆
Art Basin
Size:435x435x130mm
Above counter mounting
台面上安装

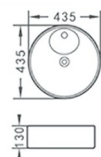

DW1438

艺术盆
Art Basin
Size:390x390x135mm
Above counter mounting
台面上安装

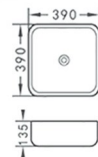

DW1447

艺术盆
Art Basin
Size:480x420x130mm
Above counter mounting
台面上安装

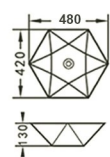



DU106

台下盆
Under Counter Basin
Size od:420x340x190mm
Size id:380x330mm
Under counter mounting
台下安装

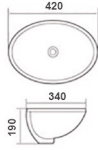

DU107C

台下盆
Under Counter Basin
Size od:470x390x190mm
Size id:415x340mm
Under counter mounting
台下安装

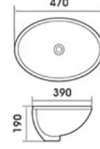

DU107D

台下盆
Under Counter Basin
Size od:490x405x210mm
Size id:445x365mm
Under counter mounting
台下安装

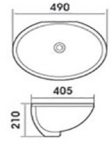

DU1601

台下盆
Under Counter Basin
Size od:400x400x180mm
Size id:360x360mm
Under counter mounting
台下安装

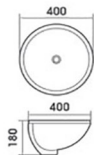

DU2002

台下盆
Under Counter Basin
Size od:500x400x200mm
Size id:445x335mm
Under counter mounting
台下安装

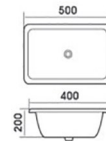

DU2013A/2013B

台下盆
Under Counter Basin
ASize od:515x385x190mm
Size id:470x335mm
BSize od:455x330x185mm
Size id:410x290mm
Under counter mounting
台下安装

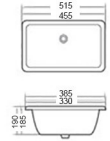

DU2015/2209/2405

台下盆
Under Counter Basin
2015Size od:460x355x190mm
Size id:400x300mm
2209Size od:520x370x200mm
Size id:470x315mm
2209Size od:595x405x205mm
Size id:535x340mm
Under counter mounting
台下安装

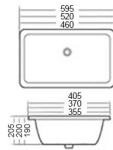

DU2105

台下盆
Under Counter Basin
Size od:530x350x180mm
Size id:485x295mm
Under counter mounting
台下安装

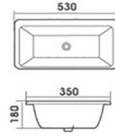

DV006

台上盆
Above counter Basin
Size:510x450x195mm
Above counter mounting
台面安装

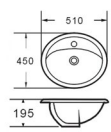

DV007

台上盆
Above counter Basin
Size:570x470x200mm
Above counter mounting
台面安装

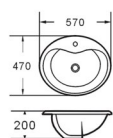

DV037

台上盆
Above counter Basin
Size:540x460x195mm
Above counter mounting
台面安装

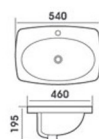

DV050

台上盆
Above counter Basin
Size:580x460x235mm
Above counter mounting
台面安装

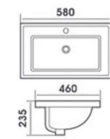



Product/儿童座便器

Line graph/产品线图

排水:直冲式
尺寸:500x285x530毫米
坑距:200/300毫米

Children washdown one-toilet
Size: 500x285x530mm
Pit distance: 200 / 300mm

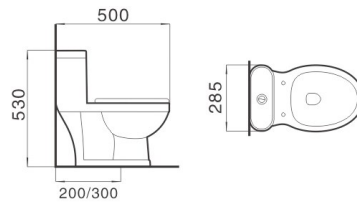

DA222 Colour/颜色选择



Product/儿童蹲便器

Line graph/产品线图

带弯尺寸:400x300x190毫米 排污口了离墙280毫米
无弯尺寸:400x300x140毫米 排污口了离墙120毫米

Children squatting toilet
Have bend Size: 400x300x190mm Outfall from the wall 280mm
No bend Size: 400x300x140mm Outfall from the wall 120mm

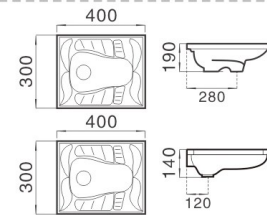

DP261 Colour/颜色选择



Product/儿童小便斗

Line graph/产品线图

尺寸:285x240x490毫米
挂墙式安装

Children wall-hung urinal
Size: 285x240x490mm
Wall-mounted installation

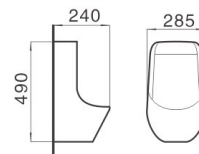

DX260 Colour/颜色选择





Product/儿童立柱盆

尺寸:420x360x550毫米
靠墙式安装

Children's pedestal basin
Size: 420x360x550mm
Fixing to wall with back

Line graph/产品线图

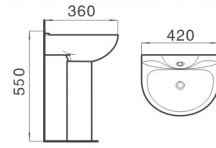

DW296 Colour/颜色选择



佩奇

白

橙

粉

黄

绿



Product/儿童艺术盆

尺寸:360x360x140毫米
尺寸:400x400x140毫米
台上安装

Children's art basin
Size: 360x360x140mm
Size: 400x400x140mm
Above counter mounting

Line graph/产品线图

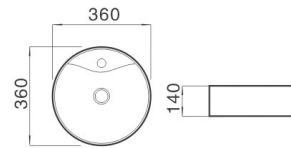

DW206 Colour/颜色选择



佩奇

白

粉

黄

绿

蓝



Product/儿童台下盆

13寸尺寸:330x290x165毫米
14寸尺寸:360x290x170毫米
台下安装

Children under the basin
13"Size: 330x290x165mm
14"Size: 360x290x170mm
Under counter mounting

Line graph/产品线图

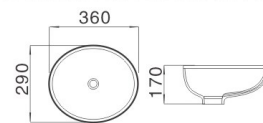

DU265(13寸) **DU266**(14寸) Colour/颜色选择



佩奇

白

橙

粉

黄

蓝



Our company holds the right to improve the appearance, dimension and technology of the products without prior notice.
本公司保留对产品外观·尺寸及技术改进的权利, 如有变更恕不另行通知。

Chaozhou Dooway Sanitary ware factory
Add:Guayuan West Road,Changmei Er,Fengxi District,
Chaozhou City,Guangdong province,China.
T:0086-768-6876986 F:0086-768-6876986
M:+86-13421059944 E:salesmanager@doooway.com
Website:www.doooway.com
www.doooway.en.alibaba.com
Skype:dooowaysunny
Wechat:+8613421059944/+8615216959942
Whatsapp:+8613421059944
Facebook:salesmanager@doooway.com



We Chat