

秦皇岛北方船舶机械进出口有限公司

QINHUANGDAO BEIFANG MARINE POWER & MACHINERY IMP. & EXP.CO.,LTD.

地址：河北省秦皇岛市经济技术开发区黑龙江西道39号

传真：+86-0335-3219383

官网：www.bfmp.net

Address: No. 39 Heilongjiang West Road, Economic and Technological
Development Zone, Qinhuangdao City, Hebei Province,China.

Fax: +86-0335-3219383

Website: www.bfmp.net/en/

目 录 CONTENTS

- 公司简介 < ABOUT BFMP >
- 船舶配套 < Ship Supporting >
- 新造船 < Ship Building >
- 大功率柴油电站 < Power Plant >
- 新能源 < New Energy >
- 备件 < Spare Parts >
- 产品代理 < Products Agency >
- 试验工厂 < R&D Workshop >

公司简介

秦皇岛北方船舶机械进出口有限公司，成立于1993年，是由一批经验丰富的轮机技术和贸易人员组成的技术贸易型企业。

三十年来，我司秉承“以产品代理为中心，以新能源产品为主线”，与全球优质供应商达成战略合作，成为包含船舶、造船、海工、新能源、陆用电站等领域在内的解决方案提供商与设备集成基地。

WE ARE BFMP

QINHUANGDAO BEIFANG MARINE POWER&MACHINERY IMP.&EXP. CO.,LTD(BFMP) founded in 1990, is a technology trade enterprise, composed of a group of experienced technical and sales experts.

Over the past 30 years, focusing on product agency & new energy products and solutions, BFMP has reached strategic cooperation with high-quality global suppliers, supporting our clients by providing equipment and solutions in the fields of marine, shipbuilding, offshore engineering, new energy, and land-based power stations, and etc. to save their time and money.

主营业务

1. 电站设备与EPC服务
2. 新能源海洋&气体发电机 船舶岸电&储能
3. 产品代理
4. 海工设备
5. 柴油机安装件及其他船用设备配件供应
6. 新造船设备打包及船舶改造服务

MAIN BUSINESS

1. Supporting power station equipment
2. New energy marine & gas generators, ship shore power & energy storage
3. Products agency
4. Offshore oil equipment and services
5. Diesel engine installation parts and other marine equipment parts supply
6. New shipbuilding equipment packaging and ship renovation service

BFMP

Ship
Supporting

Ship Building

Offshore

Power Plant

New Energy

Spare Parts

Products
Agency

R&D
Workshop

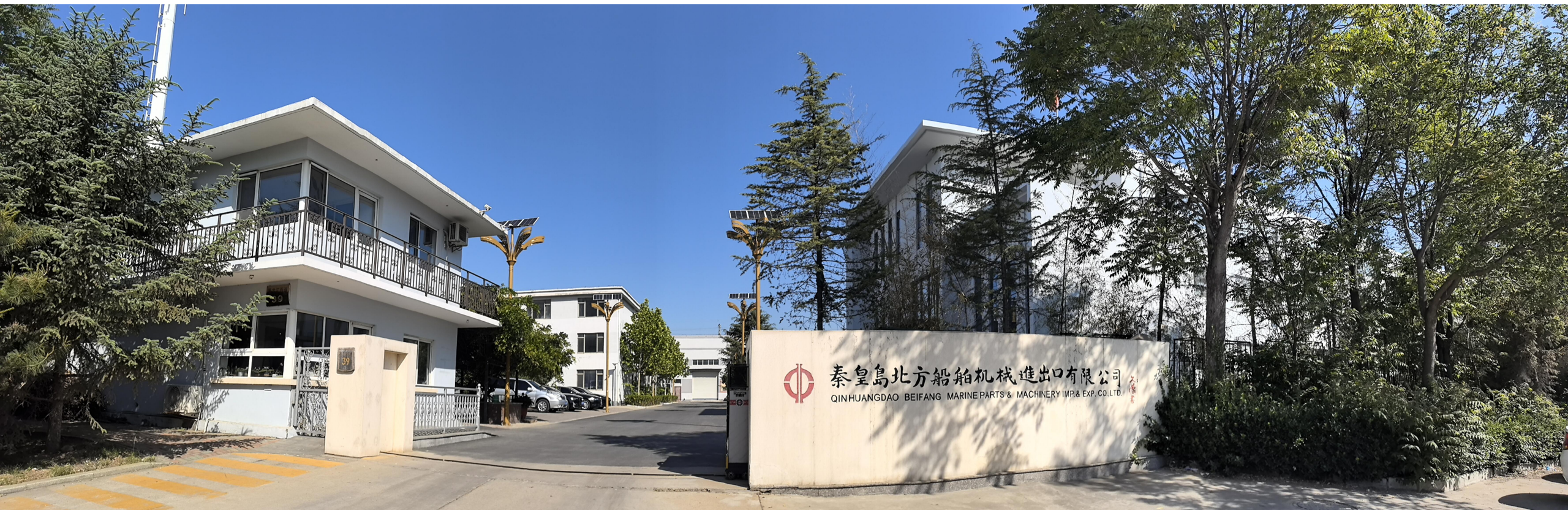

北方船舶拥有30多年外贸及进出口经验、深耕船舶动力/电力能源/海洋工程等市场、深谙客户需求、是行业领先的发动机/发电机组的专家。公司汇集了国内外行业专家顾问、技术工程师、资深营销人才、市场销售人员等，在全球拥有200多名员工，竭诚为您服务。

BFMP has over 30 years of experience, engaged in markets such as Marine power, power energy, and Marine engineering. BFMP is a leading expert in engines and generator sets in the industry.

BFMP has over 200 employees worldwide, including domestic and international industry expert advisors, technical engineers, and senior marketing talents.

电推船动力系统

- 主发电机组：500-15000 KW 中高速机组, 燃料：柴油 & DF
- 配电板：中压配电板, 高压配电板
- 变压器：可提供适配船用变压器
- 变频器：可提供适配船用变频器
- 电动机：可提供大功率推进电机, 功率500KW-25000KW
- 推进器：可提供大功率吊舱式推进器, 机械式推进器, 功率1MW-15MW

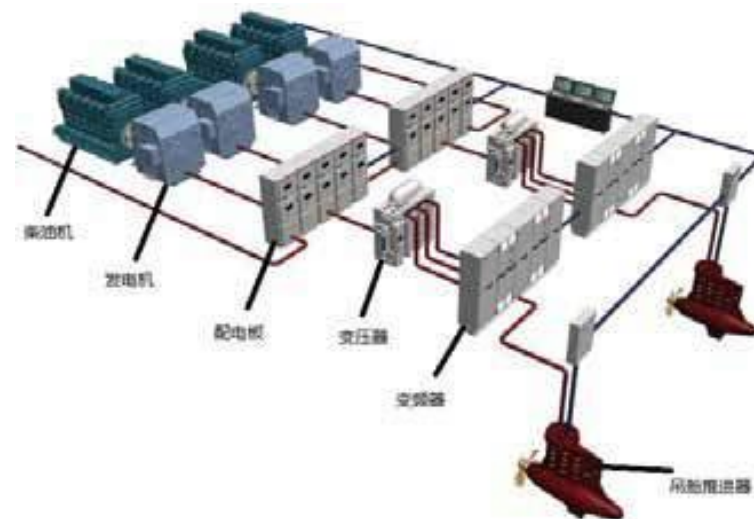

Electric Propulsion Ship

- Main generator set: can provide (500-15000) KW high speed unit, fuel: diesel or DF
- Switchboard: medium voltage switchboard, high voltage switchboard
- Transformers: Applicable Marine transformers are available
- Frequency converter: Suitable Marine frequency converter is available
- Motor: can provide high-power propulsion motor, power 500KW-25000KW
- Propeller: can provide high-power pod type propeller, mechanical propeller, power 1MW-15MW

破冰船
Icebreaker

工程船
Engineering Ship

科考船
Research Vessel

客船
Passenger Ship

新造船设备打包 New Shipbuilding Equipment Packaging
船舶改造服务 Ship Renovation Service

货船
Cargo Ship

冷藏运输船
Refrigerated Transport
Vessel

渔船
Fishing Vessel

拖轮
Tugboat

常规船舶动力系统

发动机：可提供中高速柴油机或者DF机，小功率低速机

齿轮箱：单进单出，双进单出，偏心式，同轴式

螺旋桨：FPP, CPP, Azimuth Propeller, Waterjet, Surface Drive

Ship Power System

Engine: can provide high speed diesel or DF engine, low speed engine

Gear Box: single in single out, double in single out, eccentric, coaxial

Propeller: FPP, CPP, azimuth propeller, waterjet, surface drive

其他设备

- FGSS
- 起重机 Crane
- 锚绞机 Anchor Winch
- 舵机 Steering System
- 船舶舾装 Outfitting
- 消防救生 Fir Fighting
- 空压机 Air Compressor
- 分油机 Oil Separator
- 锅炉 Boiler
- 造水机 Water Generator
- 船用空调 Air Conditioning
- 货油泵 Cargo Pump

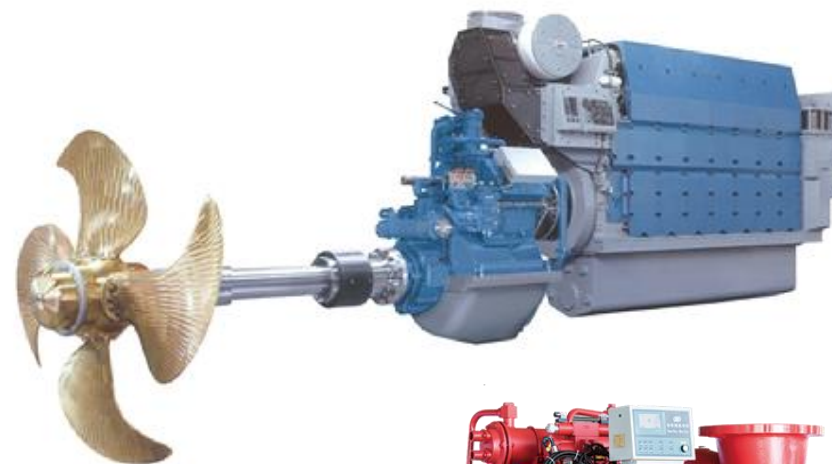

参与新造船项目50+, 30条船动力系统设备打包供应

50+ new shipbuilding projects, including packaged supply of power system equipment for 30 ships

- | | |
|----------------|--|
| • 半潜船海洋石油278 | Semi-submersible Ship "HYSY 278" |
| • 海洋石油挖沟船 | CNOOC Trenching Ship |
| • 海洋石油201 | HAI YANG SHI YOU 201 |
| • 天津海事局-海标15 | Tianjin MSA-Haibiao 15 |
| • 600吨大连海监船 | 600T Vessel for Dalian Coast Guard |
| • 青消一号消防船 | Qinxiao No.1 |
| • 600T 青岛海监船 | 600-Ton Ocean Surveillance Ship |
| • 大连600吨级海洋监测船 | Dalian 600-ton Ocean Surveillance Ship |
| • 600吨秦皇岛海监船 | 600T Vessel for QHD Coast Guard |
| • 警用船 公安006 | China Police Ship 006 |
| • 沧航浚 1号 & 2号 | CANG HANG JUN 1 & 2 |



DIESEL GENERATOR SETS IN STOCK

我司拥有丰富发电机组库存资源，为世界各地电站项目提供电力支持

BFMP has various generator sets in stock available for sale, supporting global power plant projects.

| 品牌 Brand | 型号 Model | 功率 Power | 转速 Rotate Speed |
|-------------|-------------|-------------|--------------------|
| STX-MAN | 8L27/38 | 2640 | 720 |
| DOOSAN-MAN | 6L27/38 | 1980 | 720 |
| DOOSAN-MAN | 9L21/31 | 1980 | 1000 |
| DOOSAN-MAN | 5L21/31 | 940 | 900 |
| EURO-MAN | 12VP185 | 2720 | 1937 |



北方船舶

船舶配套

新造船

海洋石油

大功率
柴油电站

新能源

备件

产品代理

试验工厂



离岸平台 海洋石油工程 服务

Offshore Oil Engineering Service

为海洋石油开采、提炼、储存运输、装卸计量等环节提供一系列解决方案
及行业领先技术的设备和配件

Offshore Oil Engineering Service

- 钻井设备 Drilling Equipment
- 动力设备 Power Equipment
- 采油设备 Oil Extraction Equipment
- 储运设备 Storage Equipment
- 起重设备 Crane
- 通讯和导航系统 Navigation Systems
- 零配件 Spare Parts

- 海工吊机 Offshore Crane
- 防喷器 BOP
- 分流器 Diverter
- 钻机 Drilling Rig
- 消防系统 FIFI System
- 除泥器 Desilter
- 单点系泊 SPM

- 顶驱 Top Drive
- 泥浆泵 Mud Pump
- 伸缩桨 Retractable
- 升降模块 Lift Modular
- 绞车 Winch
- 井架 Drilling Motor
- 固控系统 Integrated Driller

BFMP

Ship Supporting

Ship Building

Offshore

Power Plant

New Energy

Spare Parts

Products Agency

R&D Workshop

钻井平台
Drilling

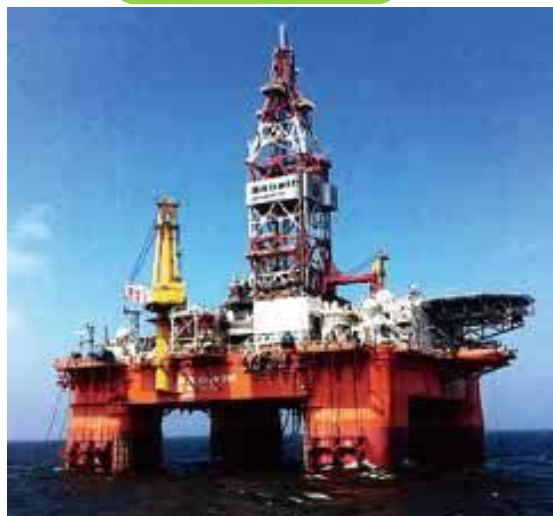

采油船
FPSO



半潜船
Semi-submerged Ship



采油平台
Passenger Ship



工作船
AHTS



电站配套与服务 Powerplant service

参与10新建电站项目的设备供应
20电站的大修
8电站技术服务

新建电站产品和服务

Services for New Build Power Plant

- 电站总包 EPC Power Plant EPC
- 电站设备打包EP EP for Power Station
- 发电机组 Generator Set
- 燃气轮机和蒸汽轮机 Gas and Steam Turbines
- 锅炉 Boiler
- 选择性催化还原 SCR
- 电站撬块等 Modular for Power Plan

电站设备专家 服务全球



发电机组

ENGINE GENERATOR SET

Supply high, medium and low speed engines.
Power Range: 100KW-13MW
Fuel Types: HFO, LFO, MGO, LNG



燃气发电机组 Gas Generator Set

2023年成功交付18MW气体机电站，赢得业内客户群体一致好评。

The 18MW gas power station has been successfully delivered in 2023, winning unanimous praise from customers in the industry.



燃气轮机 Gas Turbine

供应燃气轮机，功率范围3MW-120MW。根据用户要求选择合适的燃气轮机原装备件和OEM配件。

Supply gas turbines, power range 3MW-120MW. Select suitable gas turbines according to user requirements original spare parts and OEM parts.



优势Advantage

- 高效性，减少能源浪费。
- 较低排放，减少空气污染和温室气体排放。
- 可再生能源协同应用，保证电网的稳定性。
- Efficiency, reducing energy waste.
- Lower emissions, reducing air pollution and greenhouse gas emissions.
- The coordinated application of renewable energy

电站的能效升级和清洁排放解决方案

- 油改气，柴油发电机组升级为双燃料或气体发电机组
- 余热利用
- SCR装置和脱硫塔 热效率提高 清洁排放
- Oil to gas, diesel generator upgrade to dual fuel or gas generator
- WHR System
- SCR

油改气

Gas Conversion

柴油机转换为气体/双燃料机

Diesel engines converted to Gas / Dual-fuel engines

- Minimal change
- 80%-100% of the original power
- Thermal efficiency 40%-46%
- Less carbon emissions, less pollution

效率提升!

CO2 SO2 NOx排放大大降低!

岸电受电系统

Shore Power Systems for ports & ships

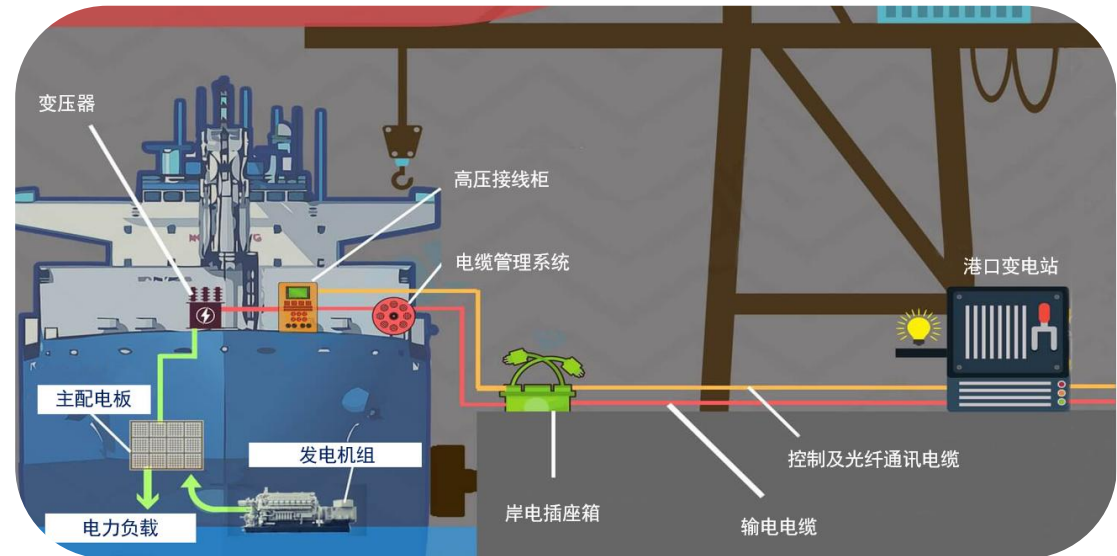

- ✓ 岸电 Shore Power System
- ✓ 储能解决方案 Energy Storage Solution
- ✓ Complete Battery Storage Systems for Ports & Retrofit or Newbuilt Vessels

SCR System

Selective Catalytic Reduction

选择性催化还原(SCR)是减少内燃机等设备尾气Nox排放的有效设备。北方SCR主要应用于船舶和电站, Nox转化率高于90%。满足船舶TIRE III 排放要求, 可根据不同发动机型进行定制化匹配, 和船级社认证。

We supply customized SCR to meet diverse engines of diverse classification society. Selective Catalytic Reduction (SCR) is the effective equipment to reduce Nox emission. It enables the ship to reach TIRE 3 emission standard.

We have solutions to recover the exhaust heat for existing generators and new project. And a SCR and other exhaust treatment equipment could also be added to the co-generating system if you have.

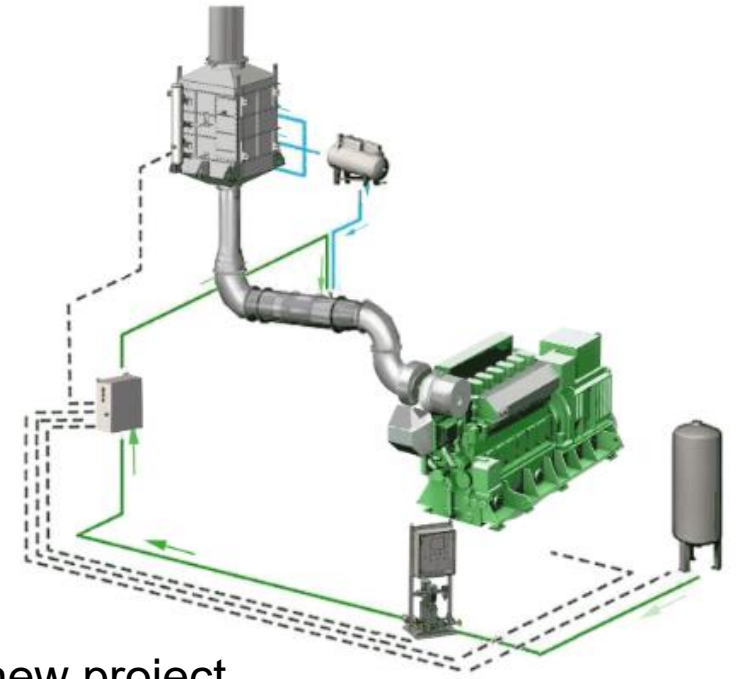

Co-generating Selective Catalytic Reduction

- 保证8-12%的功率提升
- 改造成本2-3年回收
- 全球提供EPC与BOP解决方案
- We promise a 8-12% increase of power
- Recover the cost of Co-generation in 2-3 years
- Provide EPC or BOP solutions worldwide

电缆管理系统

CMS Cable Management System

履带式行走底盘可适应矿上道路条件

底盘通过高度：500mm

适用温度：±45℃

爬坡能力：15°

24小时连续工作

电机驱动

Features:

Heigh of chassis: 500mm

Applicable temperature: ±45℃

Climbing capacity: 15°

24 hours of continuous work

Motor drive



Benefits



- Intelligent following: Automatically follow the working equipment within the preset range to improve operating efficiency
- Cable adjustment: Automatically retract and retract the cable according to real-time requirements, and can be operated remotely
- Cable protection: Solve the cable line damage that may be caused by cable not timely recovery
- Safety: Improve worker safety by eliminating dangerous manual cable handling steps

Cable Management System

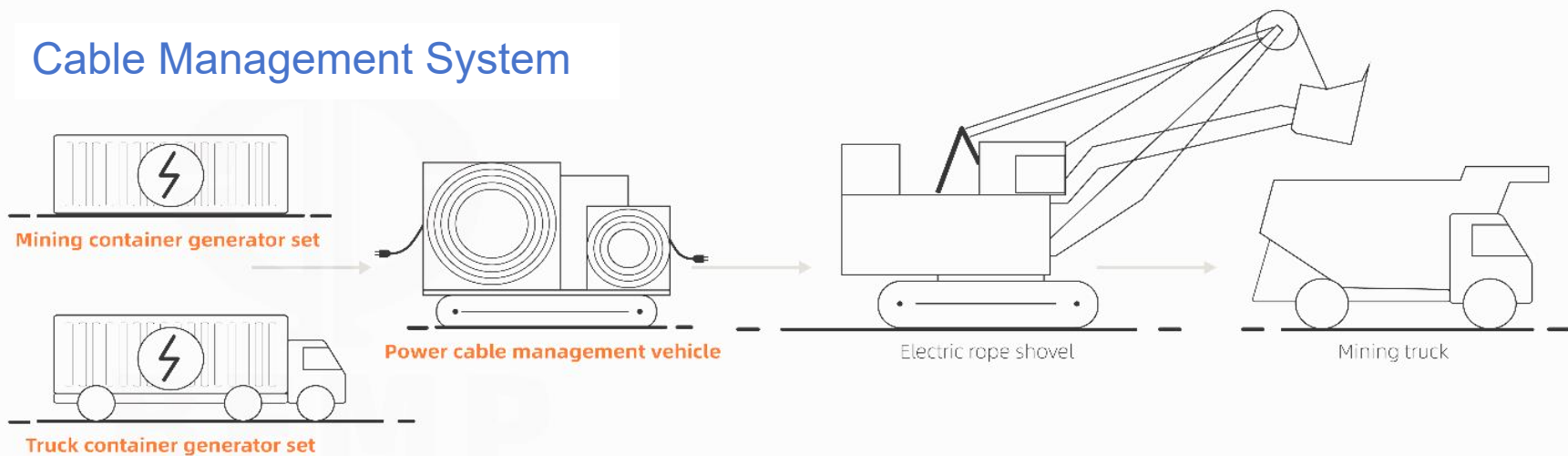

主绞盘连接移动箱式发电子组，辅助绞盘连接适配矿用机械设备，实现电压转换，电缆跟随，提高作业效率

Supply voltage: 6.6kV or 10kV
Main winch cable length: 500 m
Auxiliary winch cable: 50-80 m



Adaptation:

- CAT、Komatsu、Liebherr electric excavator/electric rope shovel
- Epiroc Boomer series Drilling rig
- Electric ore conveyor
- Main cable length over 1000m can be customized

遥控模式 (Operation mode) :

- 本地操作(Local operation)
- 无限远程操控(wireless remote control)
- 远程操控(remote control optional)
- 智能自动跟随 (intelligent automatic follow optional)

备件

Spare parts

服务全球1000+船东, 20+造机厂, 与100+厂家与品牌合作

船用备件AAT

造机厂CKD

柴油机/气体机部件: 曲轴、机体、缸盖、连杆、活塞、活塞环、燃油泵、喷油嘴、凸轮轴、气阀、阀座

Engine Parts:

Cylinder Head, Cylinder Liner, Piston, Connecting Rod, Fuel Injection Pump, Nozzle, Camshaft, Inlet And Exhaust Valve, Valve Seat, Gasket, O-Ring, etc.

增压机备件

船用其他设备备件

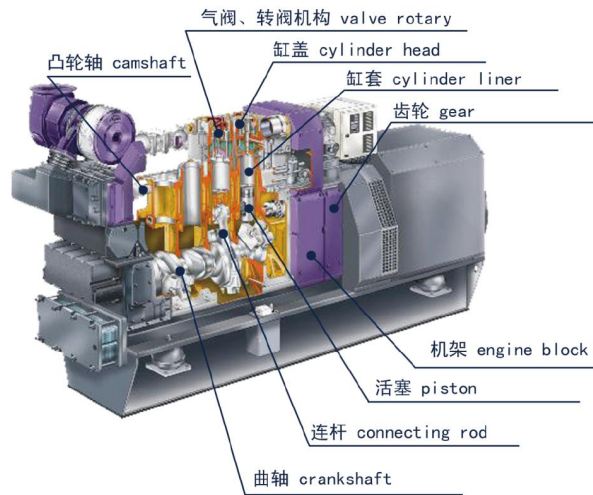
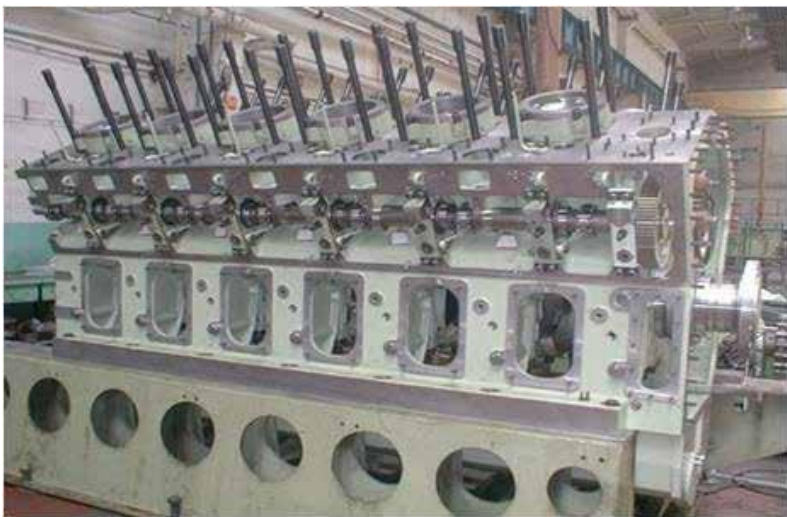

造机厂备件供应 CKD/SKD for Engine Manufacture

成功为20余家全球知名厂家提供装机件，参与供货组装柴油机，为客户降低采购成本。为中、外二十余家造机厂提供装机所需部品部件，其中供应的二、四冲程进口装机件在中国装机市场占有率近60%

We have successfully provided installed parts for World famous diesel engine manufacturers. We have participated in supplying diesel engines assembled by Wartsila, reducing procurement costs. For more than 20 domestic and foreign machine manufacturers to provide parts required for installation, of which the supply of two, four stroke imported installed parts in China's installed market share of nearly 60%.



北方船舶

船舶配套

新造船

海洋石油

大功率
柴油电站

新能源

备件

产品代理

试验工厂

GE发动机

我公司主要代理GE船用 L250 和 V250 系列柴油发动机，为全球船舶市场提供动力。

ABC发动机

功率范围从600KW至10400KW。转速300-1000rpm，特别适合于拖轮、挖泥船等工程船只。应用领域船舶推进、陆用发电和铁路牵引动力。

2G燃气发电机组

产品功率20KW至4.5MW的，满足了多样化的能源需求。热利用率高。噪音水平低至52/45dB。

上海菱重发动机

主要产品S6R2/S12R/S16R 系列各型号发动机，该系列产品主要用于陆用发电机组，功率覆盖为500KW-2000KW。

玉柴发动机

产品功率覆盖15kW-4200kW，涵盖10大平台 30 大系列，产品包括柴油机、燃气机等，用于船舶和发电设备等装备配套。

陕柴发电机组

船用发动机：735kW-12000kW
船用发电机组：418KW-9000KW
陆用发电机组：1440kW-12000kW
核应急柴油发电机组：940kW-12000kW
燃气发电机组：940kW-12000kW

GE Engine

Our company is the main agent of GE Marine diesel engines L250 and V250 series to provide power for the global Marine market.

ABC Engine

Power ranges from 600KW to 10400KW. Speed 300-1000rpm, especially suitable for tugs, dredgers and other engineering vessels.

2G Gas Generator Set

The 2G gas generator sets with its wide power range from 20KW to 4.5MW meet diverse energy needs. High heat utilization rate. Noise level is low to 52/45dB.

Shanghai MHI Engine

Main products: S6R2/S12R/S16R series engines. These products are mainly used for land gen-sets, with power ranges from 500KW to 2000KW.

Yuchai Engine

Power ranges from 15 KW to 4,200 KW, our products cover 30 series across 10 platforms, including diesel engines and gas engines, etc.

SXD Generator Set

Marine Engine: 735kW-12000kW
Marine Gensets: 418KW-9000KW
Land Gensets: 1440kW-12000kW
Nuclear Emergency Diesel gensets: 940kW-12000kW
Gas gensets: 1200kW-8280kW

济柴气体机

功率范围

天然气发动机：功率范围覆盖 300kW 至 4000kW。

沼气发动机：功率范围包括 600kW、700kW、1000kW、1600kW、1800kW。

煤矿瓦斯发动机：功率范围包括 600kW、700kW、1100kW、1500kW、1800kW

应用领域

石油与天然气领域，分布式能源与热电联产，环保与资源回收，工业与基础设施等。

JICHAI Gas Generator Sets

Natural Gas Engines: The power range covers 300kW to 4000kW.

Biogas Engines: Power ratings include 600kW, 700kW, 1000kW, 1600kW, and 1800kW.

Coal Mine Gas Engines: Power ratings include 600kW, 700kW, 1100kW, 1500kW, and 1800kW.

Application:

oil and gas fields, distributed energy and combined heat and power, environmental protection and resource recycling, industrial and infrastructure, etc.

北方船舶

船舶配套

新造船

海洋石油

大功率
柴油电站

新能源

备件

产品代理

试验工厂

北方船舶试验工厂



BFMP

**Ship
Supporting**

Ship Building

Offshore

Power Plant

New Energy

Spare Parts

**Products
Agency**

**R&D
Workshop**

BFMP R&D Workshop

